



PRODUCT CATALOGUE

Manufacturer Of Surgical Instruments
Since 1993





Since 1993

“Instruments Partner in Precision Surgery”



Hello,

Our journey in surgical instrument manufacturing began in 1993. Today, our second generation has elevated it to a state-of-the-art facility, crafting the finest surgical instruments.

We are committed to sharing the expertise we have gained over decades with each customer, and this drive for excellence has led us to adopt the best technologies from around the globe.

This catalog contains our complete range of surgical instruments and best practices for maintaining them. However, in line with our ongoing quest for refinement and new product additions, we invite you to connect with us for the latest updates.

Our microsurgical instruments, precisely crafted by skilled artisans and supported by advanced computer-controlled technologies, offer meticulous control, sensitive tactile feedback, superior balance, and attention to even the smallest details.

As a manufacturer, our goal is to be perceived as a partner offering solutions, rather than merely a seller.

Founder

K C SEKARUDU

<i>Advantages of Titanium Instruments</i>	v
<i>Maintenance Instructions</i>	vi
<i>Warranty Terms</i>	vii
<i>Understanding Warranty Codes</i>	viii

01

MICRO INSTRUMENTS

Needle Holders	1.1
Scissors	1.5
Ring Tip Forceps	1.12
Micro Debakey Forceps	1.15
Platform Forceps	1.20
Delicate Forceps	1.22
Debakey Forceps	1.23
Resano Forceps	1.26
Coronary Probes	1.27
Bulldog Clamps	1.28
Dessectors	1.30

02

DEBAKEY VASCULAR CLAMPS

Ring Handle Bulldog Clamps	2.1
Neonatal Castaneda Clamps	2.3
Deep Curved Multi Purpose Clamps	2.5
Angled Multi Purpose Clamps	2.6
Derra Cooley Clamps	2.7
Side Biting Clamps	2.9
Ligature Clamps	2.10
Beck Clamps	2.11
Herken Clamps	2.12
Tangential Occlusion Clamps	2.13
Satinsky Clamps	2.14
Lambert-Key Clamps	2.15
Arota Clamps	2.16

SEMB Arota Aneurysm Clamps	2.17
Arota Aneurysm Clamps	2.18
Straight Clamps	2.19
Cross Clamps	2.20
Price-Thomas Vascular Clamp	2.26

TITANIUM MICRO CLAMPS

Debakey Straight Clamp	2.27
Debakey Side Biting Angled Clamps	2.28
Debakey Angled Clamps	2.29

03

MICS INSTRUMENTS

Intercostal Retractor Set	3.1
IMA Retractor Arc and Coupler Set	3.2
LA Attachment Set	3.3
Mini-sternotomy and Mini-thoracotomy Retractor	3.4
Long Valve Forceps	3.5
Clip Applicators	3.7
Knot Pushers	3.8
Chitwood Debakey Clamps	3.10
Nerve Hook	3.11
Cardiotomy Suckers	3.12

04

PTE INSTRUMENTS

PTE (Madani) Debakey Forceps	4.1
Pulmonary Endarterectomy Dissector	4.2

GENERAL INSTRUMENTS

BP Handles	5.1
Forceps	5.3
Scissors	5.20
Needle Holders	5.26
Sternal Needle / Wire Twister	5.30
Wire Holder	5.31
Dissecting Forceps	5.32
Tube Holding Instruments	5.37
Wire Cutters	5.40
Dilators	5.41
Hollow Wares	5.43

RETRACTORS

Rib / Sternal Spreaders	6.1
Self Retaining Retractors	6.14
Aortic Valve Retractors	6.17
Cooly Mitral Valve Retractors	6.18
Langenbeck Retractors	6.20
VSD Retractors	6.22
Harrington Retractors	6.23
Davers Retractors	6.24
Davidson Retractors	6.25
Allison Lung Retractors	6.26
Mories Retractors	6.27
Rack Retractors	6.28
Zereny Retractor	6.30
Epicardial Fat Retractors	6.31
Malliable Retractors	6.32
Hooks	6.33

07

SUCTION INSTRUMENTS

Cardiotomy Suction Tubes	7.1
Rough Suction Tubes	7.2
Suction Tips	7.3
Suction Tips & Cannulas	7.4

08

BONE INSTRUMENTS

Bone Cutters	8.1
Elevators	8.3
Rongeurs	8.6

09

TRAYS AND CONTAINERS

SS Trays with Lid	9.1
Micro Instruments Tray	9.2

ADVANTAGES OF TITANIUM INSTRUMENTS

- **Light Weight:** 45% lighter than stainless steel, reducing fatigue for surgeons during long operations.
- **No Rust – Long Life:** Excellent corrosion resistance, ensuring a longer lifespan.
- **Less Traumatic:** Titanium clamps provides atraumatic occlusion, making them ideal for various surgical applications.
- **Antimagnetic:** Prevents needle holders from sticking to suture needles.
- **Maintenance/Cleaning:** Easy to maintain with standard cleaning procedures.
- **Easy Identification:** Anodized in blue colour for simple identification.



[Go to Index](#)

MAINTENANCE INSTRUCTIONS

To protect your valuable investment in surgical instruments please follow below instructions,

Treatment of New Instruments

- Brand new instruments must be cleaned and sterilized before the first use. Ensure protective caps and layers are completely removed, especially on microsurgical instruments.
- Lubricate surgical instruments before sterilization to enhance their performance.
- If used correctly as intended, damage to the instruments is largely avoided.

Care

- Lubricate movable parts (e.g. joints and ends) with special sterilization-capable, vapor-permeable lubricant.
- After each cleaning and disinfection process, check instruments to ensure they function properly and have not suffered any damage (e.g., bent, stained, broken, fractured, or worn parts).
- Do not use defective or nonfunctioning instruments. Evaluation and repair can be performed by our service team, and non-repairable instruments should be discarded.
- Sharpen (scissors and cutters) and maintain instruments on a regular schedule to extend their lifespan.
- Do not expose instruments to temperatures above 120 degrees, as this may weaken their functionality.

Storage

- Store instruments in an organized manner in trays and containers to prevent damage. Instruments with fine working ends and/or microsurgery instruments should have protective caps.
- Ensure all instruments are thoroughly cleaned and dried before storage to prevent corrosion and contamination.
- Keep instruments in a controlled environment, avoiding exposure to extreme temperatures and humidity.

WARRANTY TERMS

Warranty Coverage: All products are warranted against defects in functionality and materials. Any product found to be defective in workmanship or materials during supply will be repaired or replaced at our discretion, free of charge.

Warranty Period: Specific warranty periods and terms vary by product. Detailed warranty information may be included in the contract agreement.

Unauthorized Alterations: Alteration, repair, or modification of any product by unauthorized persons will void the warranty.

Correct Use: When used correctly as intended, damage to instruments is largely avoided. However, if damage occurs, possibly due to misuse, only the manufacturer can determine if it can be corrected and to what extent repairs can be made.

User Maintenance Responsibility: To ensure warranty coverage, instruments must be kept free from rust and stains. Instruments that are not properly maintained will not be eligible for warranty coverage.

Void Warranty Conditions: This warranty will be void if any instrument is used for purposes other than originally intended, not properly maintained or cleaned, or damaged as a result of misuse or accident.

"Instruments are marked with the month and year of supply to track their warranty eligibility. For more detailed information, please refer to the next page"

Return Policy

- Products must be returned unused and intact within 15 days for acceptance. After 15 days, products will not be accepted for replacement.
- Cleaning, disinfection and sterilization must be performed prior to returning the instruments. Instruments with rust or stains are not eligible for replacement.

UNDERSTANDING WARRANTY CODES

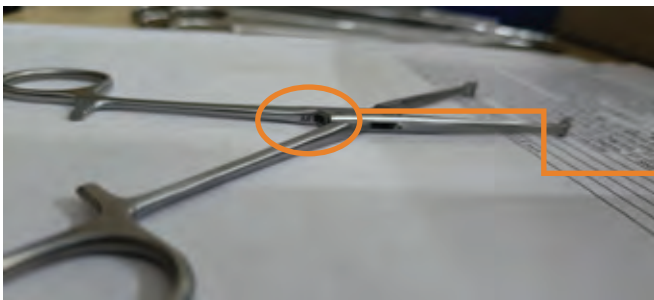

Month Code (1st Letter)	1	2	3	4	5	6	7	8	9	A	B	C
Month of Supply	Jan	Feb	Mar	Apr	May	Jun	Jul	Aug	Sep	Oct	Nov	Dec
Year Code (2nd Letter)	3	4	5	6	7	8	9	-	-	-	-	-
Year of Supply	2023	2024	2025	2026	2027	2028	2029	-	-	-	-	-

Note: The above example pictures show the locations of warranty code markings for different types of instruments. The code "A4" indicates that the instrument was supplied in October 2024 (according to the table, "A" represents October and "4" represents the year 2024).

[Go to Index](#)

MICRO INSTRUMENTS

CHAPTER - 01









[Go to Index](#)

MICRO INSTRUMENTS

Needle Holders



Micro Needle Holders (With Lock), Round Handle - Stainless Steel





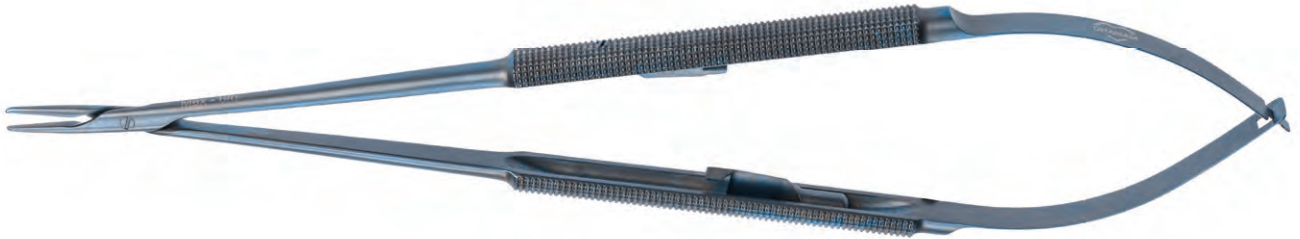

Tip Size	0.8 mm	1.0 mm	1.3 mm	1.4 mm	1.6 mm
					
Suture Size	8 / O	7 / O	6 / O	5 / O	4 / O
6"	CN 81115	CN 71115	CN 61115	CN 51115	CN 41115
7"	CN 81118	CN 71118	CN 61118	CN 51118	CN 41118
8 ¼"	CN 81121	CN 71121	CN 61121	CN 51121	CN 41121
9"	CN 81123	CN 71123	CN 61123	CN 51123	CN 41123
10"	CN 81125	CN 71125	CN 61125	CN 51125	CN 41125

MICRO INSTRUMENTS

Needle Holders





Micro Needle Holders (With Lock), Round Handle - Titanium

Tip Size	0.8 mm	1.0 mm	1.3 mm	1.4 mm	1.6 mm
					
Suture Size	8 / O	7 / O	6 / O	5 / O	4 / O
6"	CN 81115T	CN 71115T	CN 61115T	CN 51115T	CN 41115T
7"	CN 81118T	CN 71118T	CN 61118T	CN 51118T	CN 41118T
8 ¼"	CN 81121T	CN 71121T	CN 61121T	CN 51121T	CN 41121T
9"	CN 81123T	CN 71123T	CN 61123T	CN 51123T	CN 41123T
10"	CN 81125T	CN 71125T	CN 61125T	CN 51125T	CN 41125T

MICRO INSTRUMENTS

Needle Holders





Suture Size	2 / 0
	
Tip Size	2.0 mm
7 ½"	CN 21119
9"	CN 21123
10"	CN 21125

Heavy Micro Needle Holders (With Lock),
Round Handle - Stainless Steel

MICRO INSTRUMENTS

Needle Holders



Suture Size	2 / 0
	
Tip Size	2.0 mm
7 1/2"	CN 21119T
9"	CN 21123T
10"	CN 21125T

Heavy Micro Needle Holders (With Lock),
Round Handle - **Titanium**

[Go to Index](#)

MICRO INSTRUMENTS

Scissors

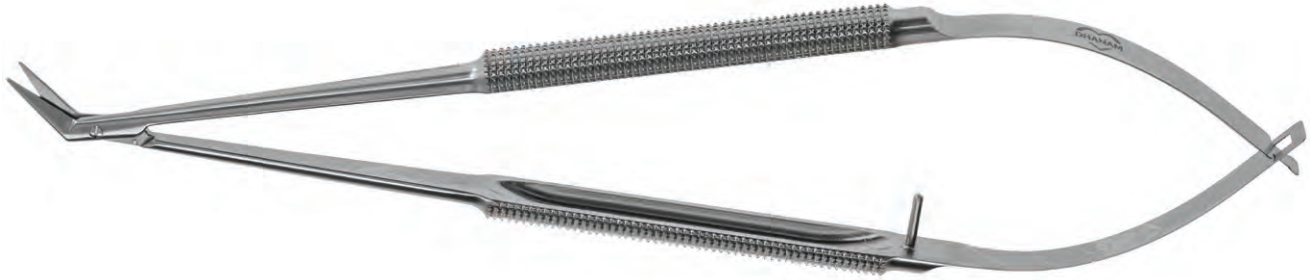





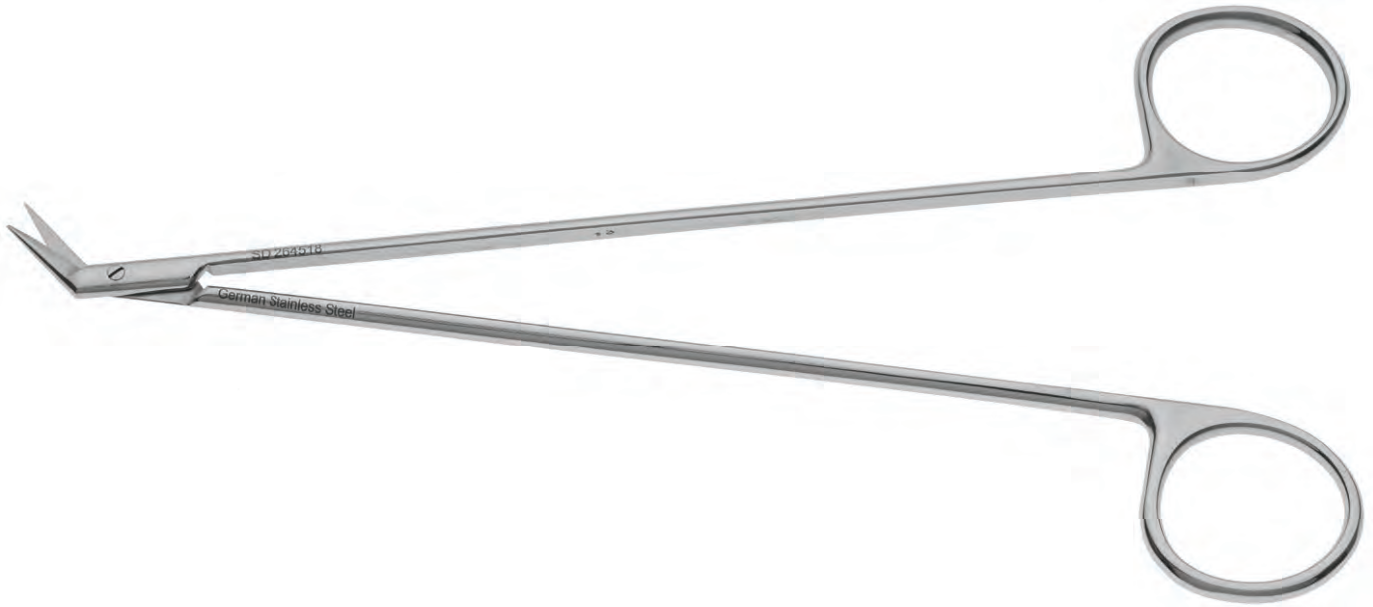

Micro Coronary Spring Potts Scissors, Round Handle

Cutting Angle		25°	45°	60°	90°	125°
LONG BLADE (10 mm)	7"	MSP 25118	MSP 45118	MSP 60118	MSP 90118	MSP 125118
	8"	MSP 25120	MSP 45120	MSP 60120	MSP 90120	MSP 125120
	9"	MSP 25123	MSP 45123	MSP 60123	MSP 90123	MSP 125123
	7"	MSP 25118S	MSP 45118S	MSP 60118S	MSP 90118S	MSP 125118S
	8"	MSP 25120S	MSP 45120S	MSP 60120S	MSP 90120S	MSP 125120S
	9"	MSP 25123S	MSP 45123S	MSP 60123S	MSP 90123S	MSP 125123S

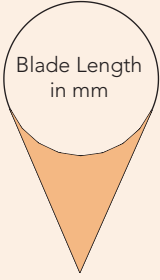
[Go to Index](#)



Diethrich Coronary Potts Scissor (Ring Type) 7" (180 mm)

Cutting Angle	25°	45°	60°	90°	125°
					
LONG BLADE (10 MM)	SD 262518	SD 264518	SD 266018	SD 269018	SD 2612518
SHORT BLADE (7 MM)	SD 262518S	SD 264518S	SD 266018S	SD 269018S	SD 2612518S

MICRO INSTRUMENTS

Scissors



Debakey Scissors 45° (Ring Type)

[Go to Index](#)



SM 250214

SM 230214

SS 210211



1/1

Tenotomy

4 1/2" (115 mm)



1/1

Sharp Tip

5" (125 mm)

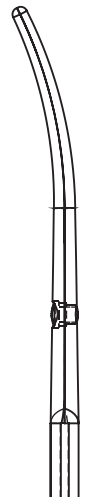

1/1

Blunt Tip

5" (125 mm)

Metzenbaum Super Cut Scissors (Ring Type)

[Go to Index](#)

MICRO INSTRUMENTS

Scissors



SR 250217

SM 230218

SM 250218

SL 250218



Ragnell



Blunt Tip



Sharp Tip



Tenotomy

Metzenbaum Super Cut Scissors 7" (180 mm)

[Go to Index](#)



SL 250223

SM 230223

SM 290223

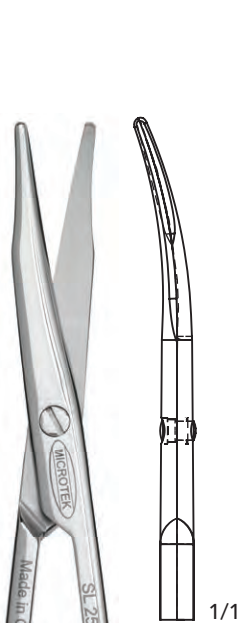

Lillehei - Potts

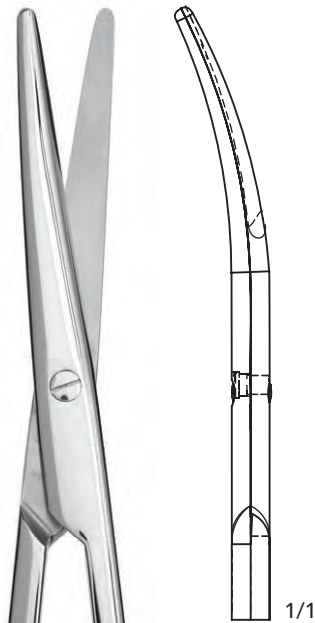

Heavy Blades



Fine Blades

Metzenbaum Scissors Super Cut 9" (230 mm)

[Go to Index](#)

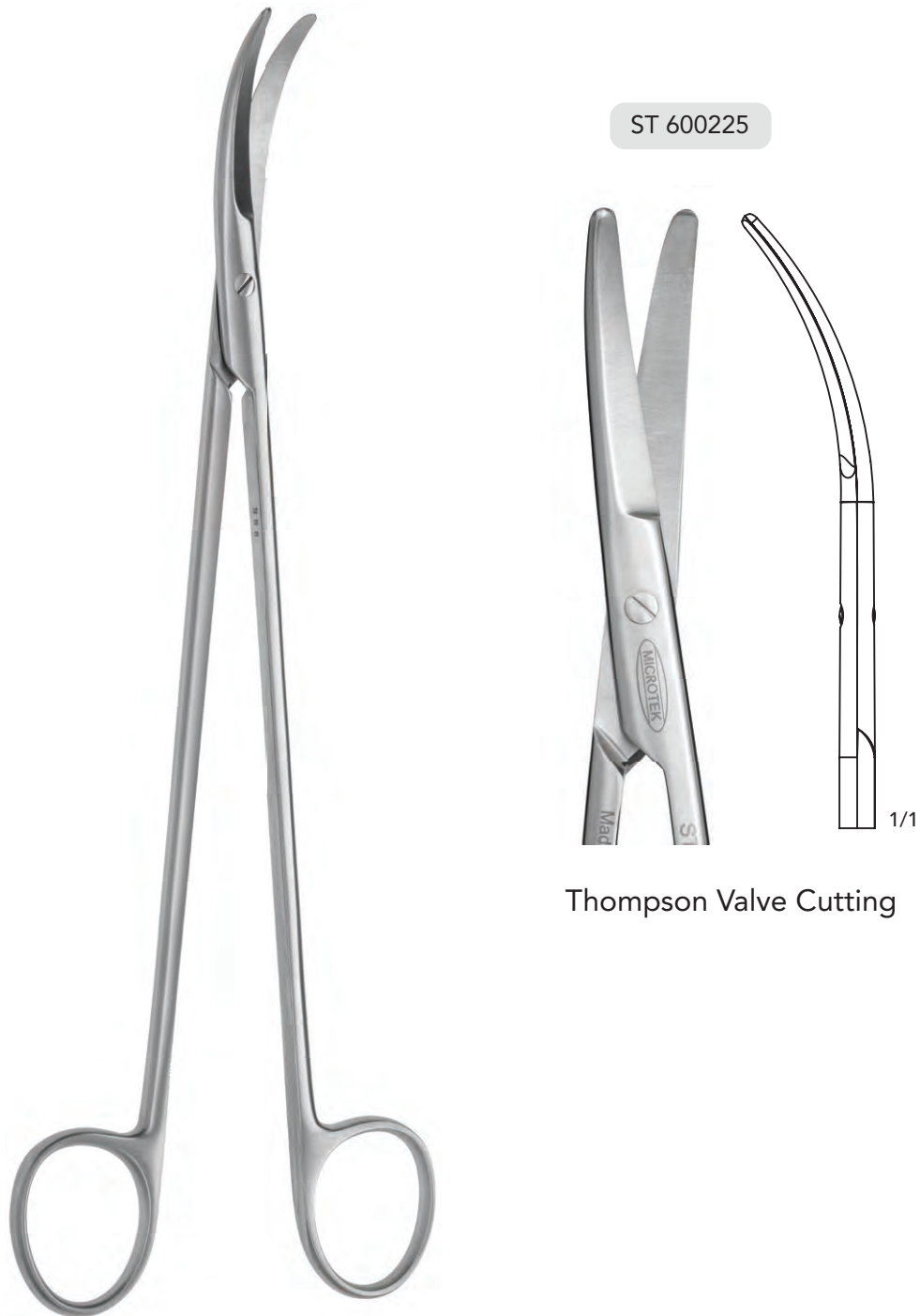

Thompson Valve Cutting Scissor Deep Curved Blades 10" (255 mm)

MFR 1023



9" (230 mm)

MFR 1021



8" (200 mm)

MFR 1018



7" (180 mm)



Micro Ring Tip Forceps Diamond Dusted,
Round Handle - Stainless Steel

[Go to Index](#)

MICRO INSTRUMENTS

Ring Tip Forceps



MFR 1023T



9" (230 mm)

MFR 1021T



8" (200 mm)

MFR 1018T



7" (180 mm)

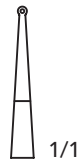

1/1

Micro Ring Tip Forceps Diamond Dusted,
Round Handle - **Titanium**

[Go to Index](#)

MFR 1123T

MFR 1121T

MFR 1118T

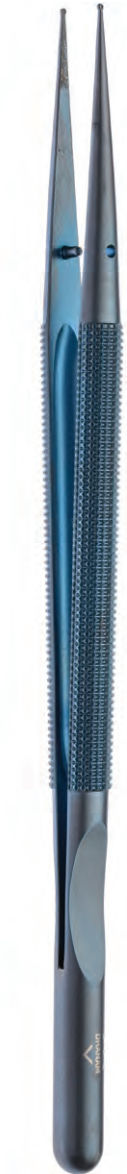
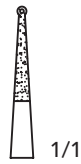

7" (180 mm)



8" (200 mm)



9" (230 mm)

Counter Balance Micro Ring Tip Forceps Diamond Dusted,
Round Handle - **Titanium**

[Go to Index](#)

MICRO INSTRUMENTS

Debakey Forceps



MFD 2023



9" (230 mm)

MFD 2021



8" (200 mm)

MFD 2018



7" (180 mm)

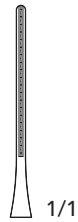

Micro Debakey Vascular Forceps, Round Handle - Stainless Steel

[Go to Index](#)

MICRO INSTRUMENTS

Debakey Forceps



Micro Debakey Vascular Forceps 45° Angled,
Round Handle - Stainless Steel

[Go to Index](#)

MICRO INSTRUMENTS

Debakey Forceps



MFD 2023T



9" (230 mm)

MFD 2021T



8" (200 mm)

MFD 2018T



7" (180 mm)

Micro Debakey Vascular Forceps, Round Handle - **Titanium**

[Go to Index](#)

MICRO INSTRUMENTS

Debakey Forceps



Micro Debakey Vascular Forceps 45° Angled,
Round Handle - Titanium

[Go to Index](#)

MICRO INSTRUMENTS

Debakey Forceps



Counter Balance Micro Debakey Vascular Forceps,
Round Handle - **Titanium**

[Go to Index](#)

MICRO INSTRUMENTS

Platform Forceps

MFP 3023



MFP 3021



MFP 3018

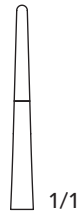

7" (180 mm)

8" (200 mm)

9" (230 mm)

Micro Platform Forceps Diamond Dusted,
Round Handle - Stainless Steel

[Go to Index](#)

MICRO INSTRUMENTS

Platform Forceps



MFP 3021T

MFP 3018T



7" (180 mm)

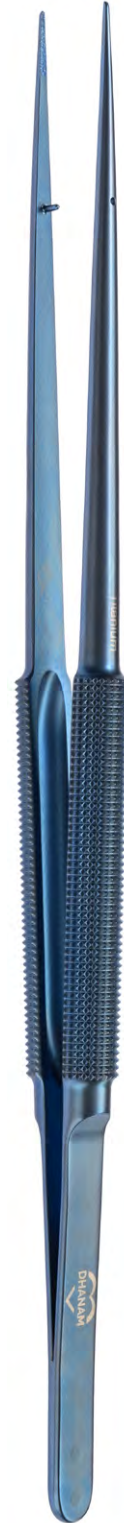

8" (200 mm)

Micro Platform Forceps Diamond Dusted,
Round Handle - [Titanium](#)

[Go to Index](#)

MICRO INSTRUMENTS

Delicate Forceps



Gerald Forceps Delicate

Thumb Forceps (Diamond Dusted)

[Go to Index](#)

MICRO INSTRUMENTS

Debakey Forceps

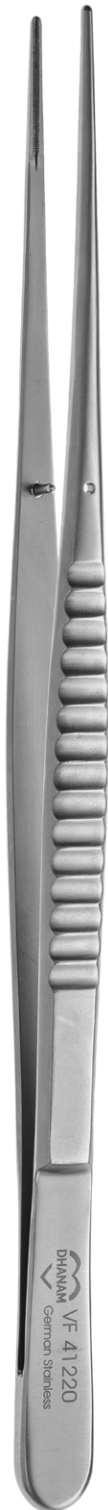

VF 39520

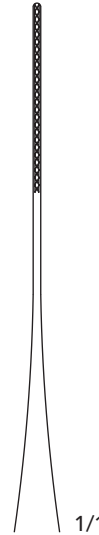

1mm Tip

8" (200 mm)

VF 39415



1mm Tip

6" (150 mm)

VF 41220

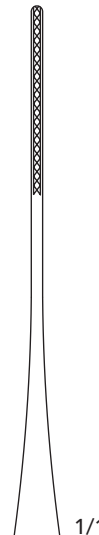

1.5 mm Tip

8" (200 mm)

VF 41115

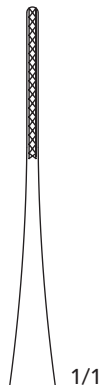

1.5 mm Tip

6" (150 mm)

Debakey Vascular Forceps (1 mm & 1.5 mm Tips)

[Go to Index](#)

MICRO INSTRUMENTS

Debakey Forceps

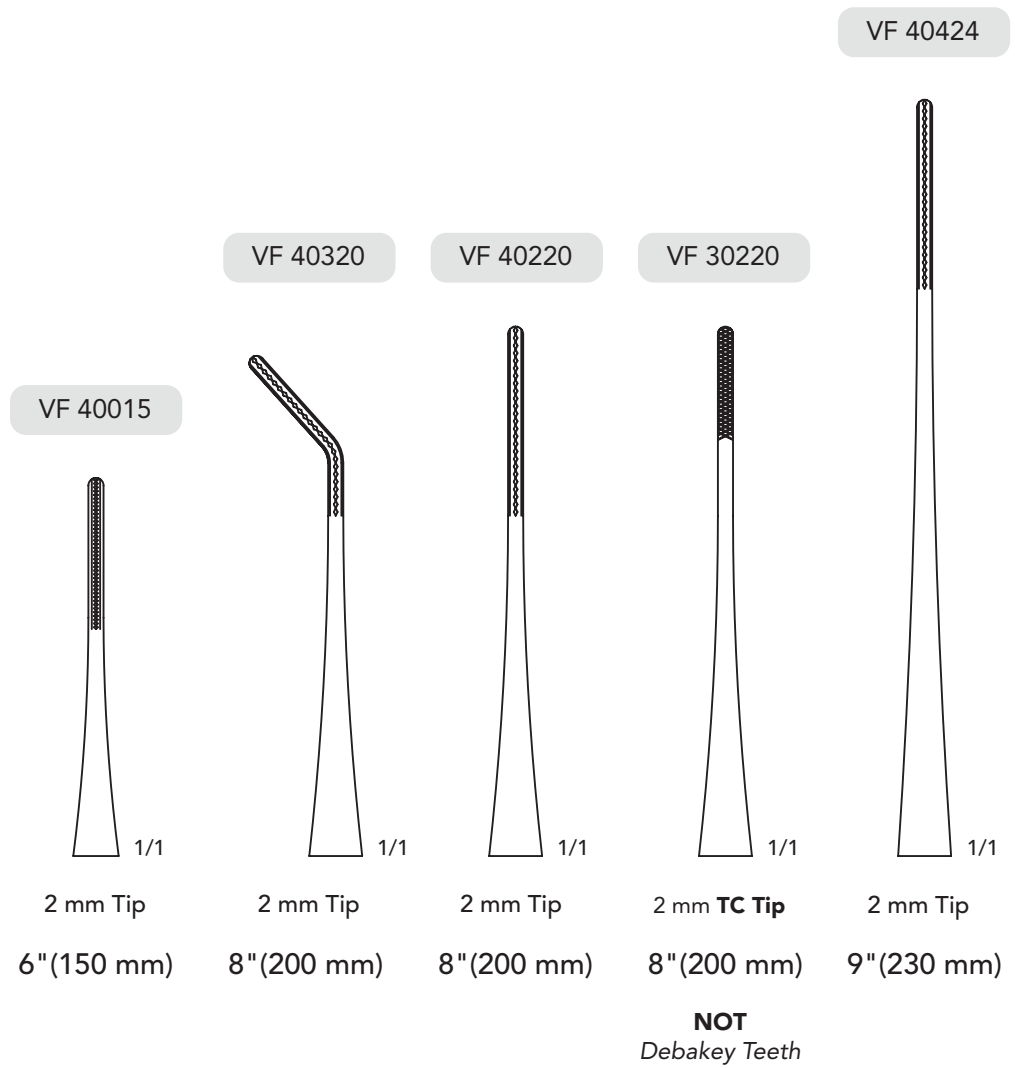

Debakey Vascular Forceps (2 mm Tips)

[Go to Index](#)

MICRO INSTRUMENTS

Debakey Forceps



VF 41624

VF 40724

VF 41520

VF 40620

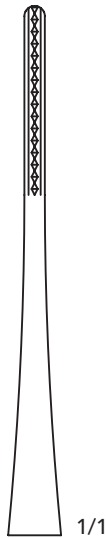

1/1

2.7 mm Tip
8" (200 mm)

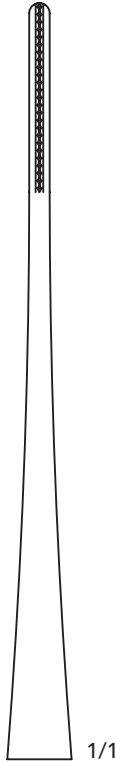

1/1

2.7 mm Tip
9" (230 mm)

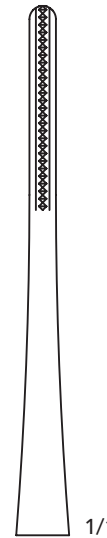

1/1

3.5 mm Tip
8" (200 mm)

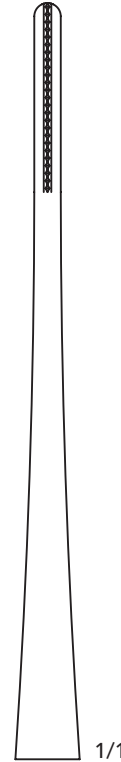

1/1

3.5 mm Tip
9" (230 mm)

Debakey Vascular Forceps (2.7 mm & 3.5 mm Tips)

[Go to Index](#)

MICRO INSTRUMENTS

Resano Forceps



VF 41024

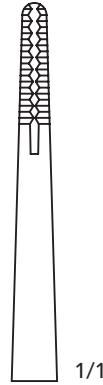

Resano Valve Forceps Multi Tooth Tip 9" (230 mm)
(For Heart Valve Removal)

[Go to Index](#)

MICRO INSTRUMENTS

Coronary Probes

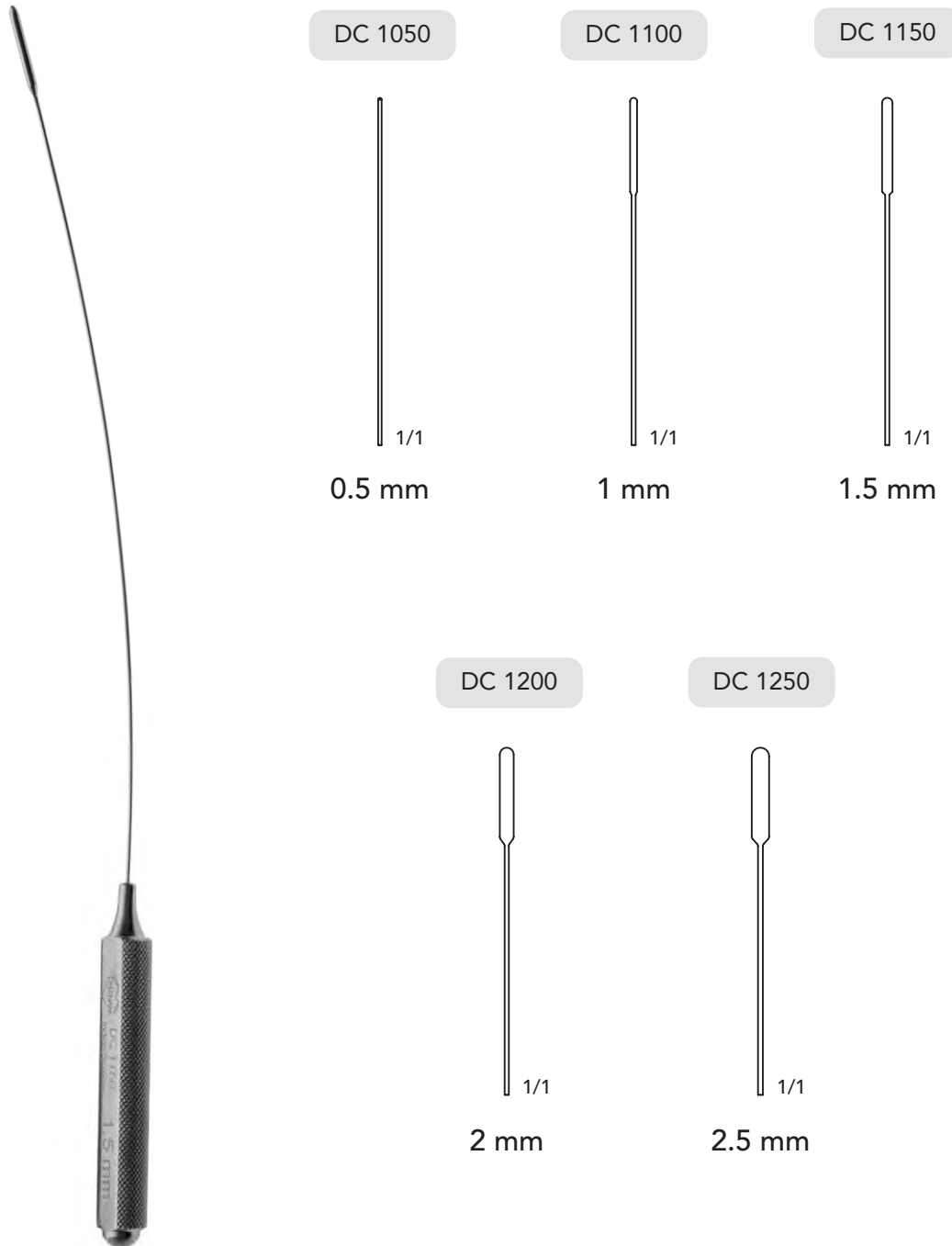

Coronary Probes 7" (180 mm)

[Go to Index](#)

BC 1105T

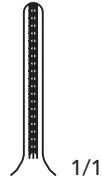

Straight

BC 1205T

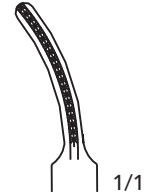

Curved

BC 1305T

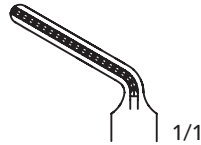

Angled

BC 3005

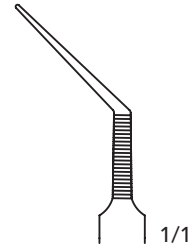

Spikey (Stainless Steel)

Debakey Bulldog Clamps 3" (75 mm) - Titanium

MICRO INSTRUMENTS

Bulldog Clamps



BA 1028



Bulldog Applicator

BT 1045

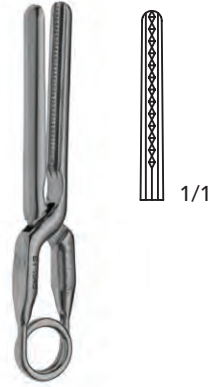

Straight 2"

BT 1145



Curved 2"

BT 1065



Straight 2 1/2"

BT 1165

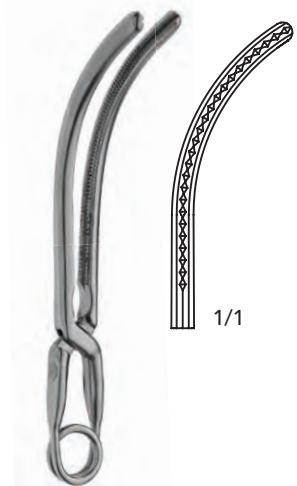

Curved 2 1/2"

Yasargil Bulldog Clips and Applier

[Go to Index](#)

DD 4120



DD 4220



DD 4320



Coronary Dessectors Double End 8" (200 mm)

[Go to Index](#)

DEBAKEY VASCULAR CLAMPS

CHAPTER - 02



[Go to Index](#)

DEBAKEY VASCULAR CLAMPS

Ring Handle Bulldog Clamps



VC 54013

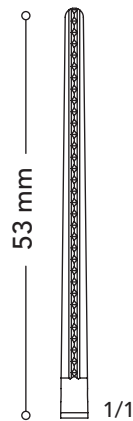

5 1/8" (130 mm)

VC 54113

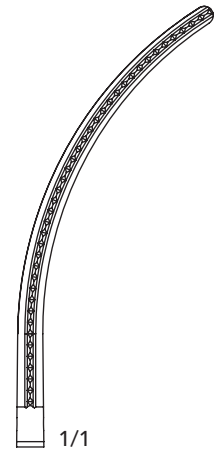

5" (125 mm)

VC 54410

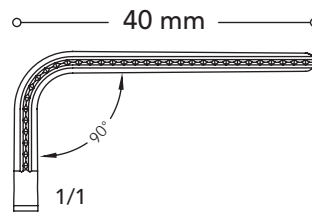

4 1/8" (100 mm)

DeBakey Ring Handle Bulldog Clamps

DEBAKEY VASCULAR CLAMPS

Ring Handle Bulldog Clamps

VC 54212

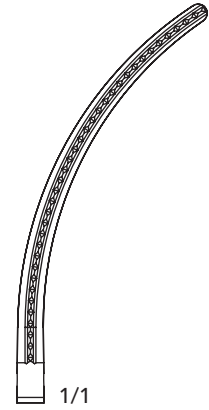

5" (125 mm)
S - Shape Curved

VC 54313

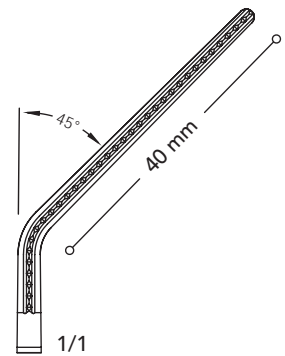

5" (125 mm)
S - Shape Angled

DeBakey Ring Handle Bulldog Clamps

[Go to Index](#)

DEBAKEY VASCULAR CLAMPS

Neonatal Castaneda Clamps



VC 58112

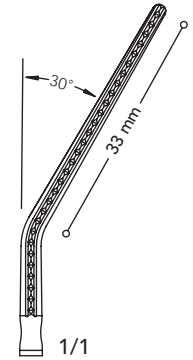

4 3/4" (120 mm)

VC 58212

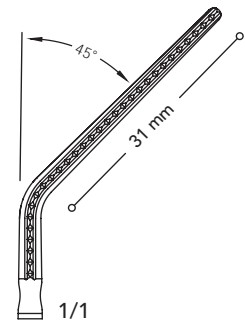

4 3/4" (120 mm)

DeBakey Neonatal Castaneda Angled Clamps

DEBAKEY VASCULAR CLAMPS

Neonatal Castaneda Clamps



VC 59015

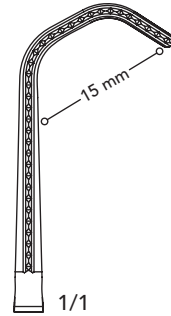

6" (150 mm)

VC 59115

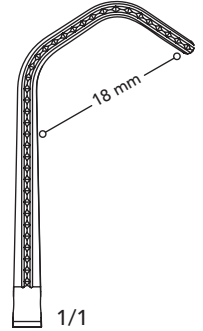

6" (150 mm)

VC 59215

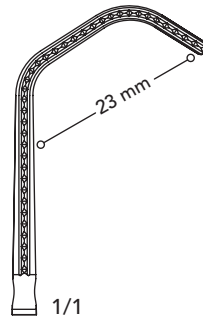

6" (150 mm)

VC 59315

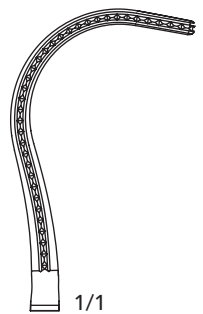

6" (150 mm)

DeBakey Neonatal Castaneda Curved Clamps

[Go to Index](#)

DEBAKEY VASCULAR CLAMPS

Deep Curved Multi Purpose Clamps

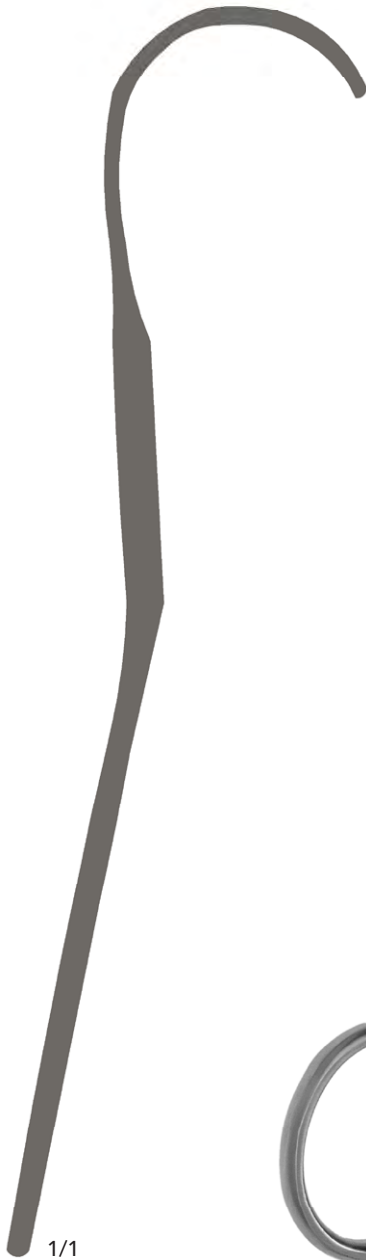

VC 55716

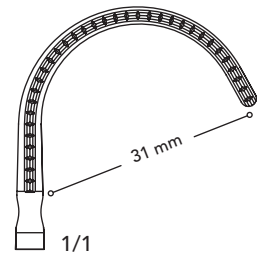

6 1/2" (165 mm)

VC 55816

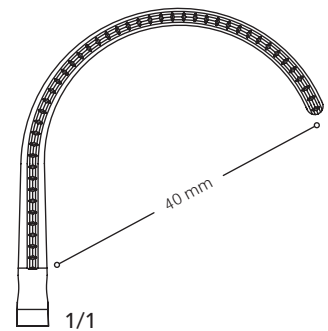

6 1/2" (165 mm)

Debakey Multi Purpose Clamps Deep Curved

[Go to Index](#)

DEBAKEY VASCULAR CLAMPS

Angled Multi Purpose Clamps

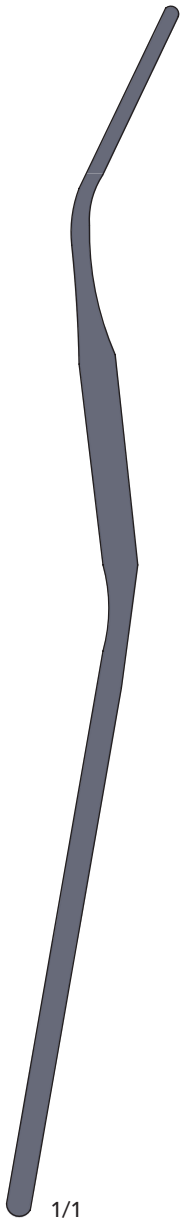

VC 56716

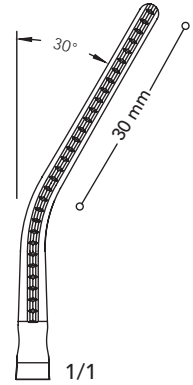

6 1/2" (160 mm)

VC 56816

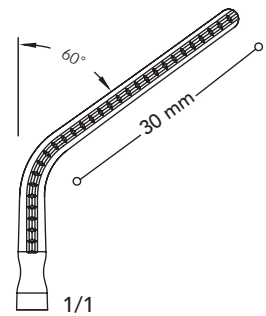

6 1/2" (160 mm)

VC 56915

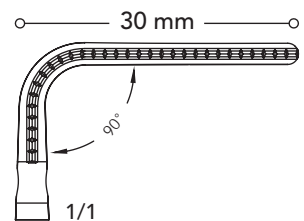

6" (150 mm)

Debakey Multi Purpose Clamps Angled

[Go to Index](#)

DEBAKEY VASCULAR CLAMPS

Derra Cooley Clamps

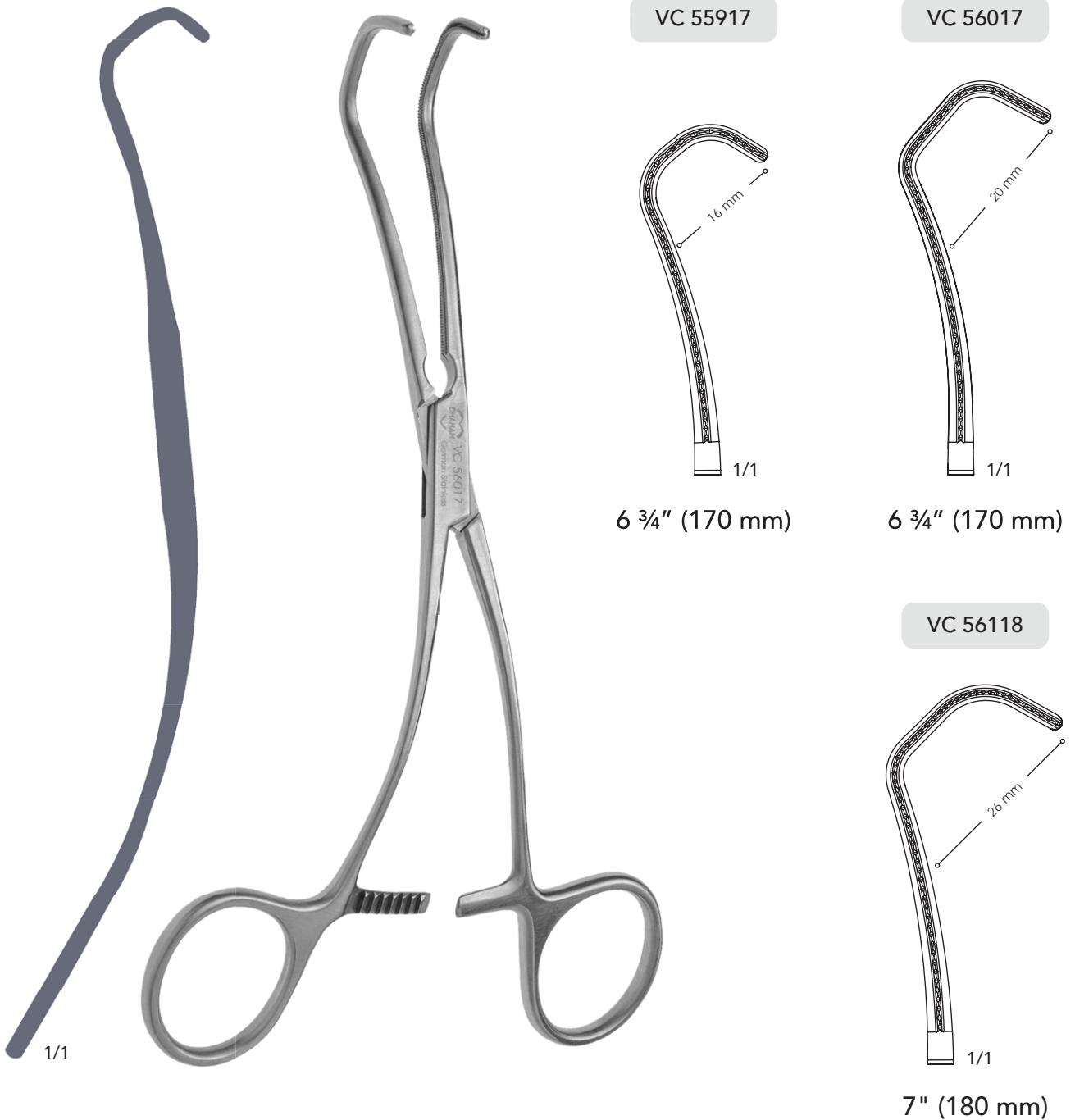

Debakey Derra Cooley Clamps

[Go to Index](#)

DEBAKEY VASCULAR CLAMPS

Derra Cooley Clamps

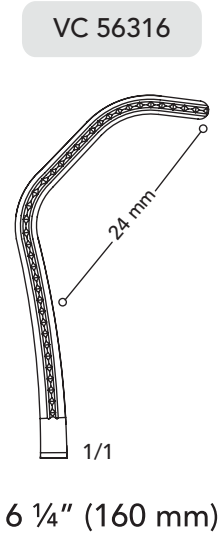

Debakey Derra Cooley Clamps

DEBAKEY VASCULAR CLAMPS

Side Biting Clamps



VC 52823

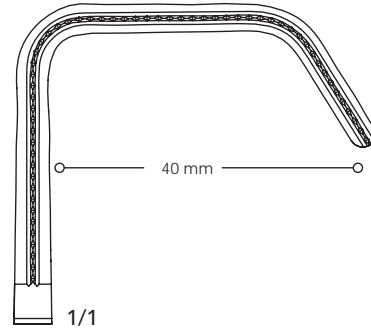

9" (230 mm)

VC 52924

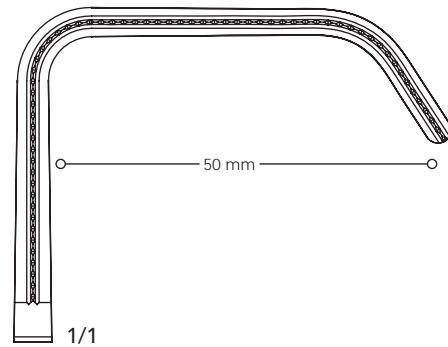

9 1/4" (235 mm)

VC 53024

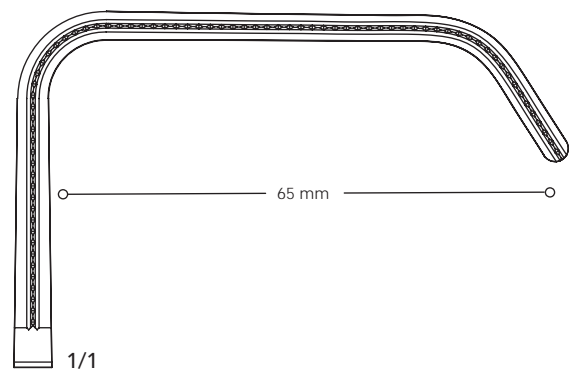

9 3/4" (245 mm)

Debakey Hopt Side Biting Clamps

[Go to Index](#)

DEBAKEY VASCULAR CLAMPS

Ligature Clamps



VC 48419

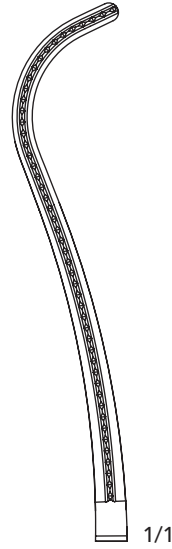

7 ½" (190 mm)
77 mm Jaw

VC 49821

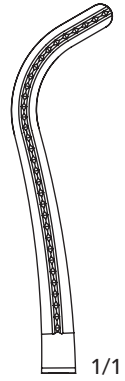

8 ¼" (210 mm)
51 mm Jaw

VC 48523

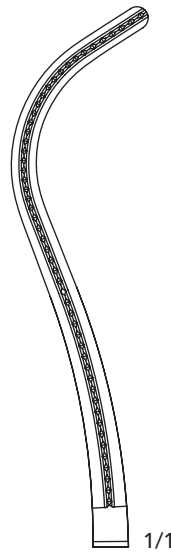

9" (230 mm)
80 mm Jaw

VC 49923

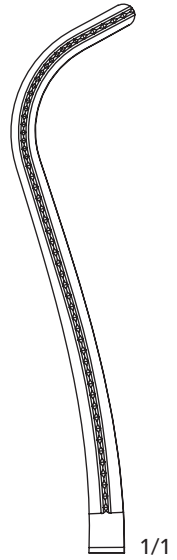

9" (230 mm)
75 mm Jaw

Debakey Ligature Clamps

[Go to Index](#)

DEBAKEY VASCULAR CLAMPS

Beck Clamps



VC 51920

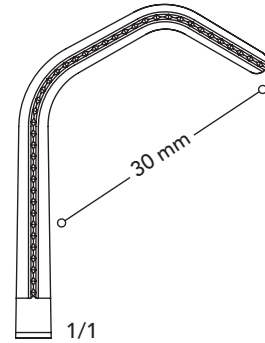

8" (200 mm)

VC 52021

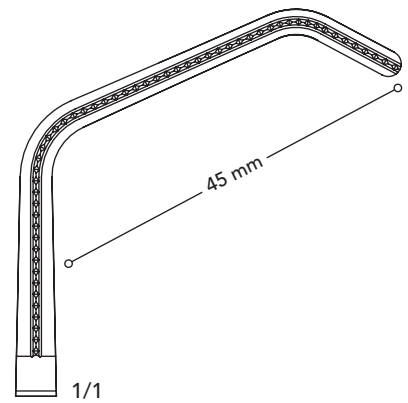

8 1/4" (210 mm)

Debakey Beck Clamps

[Go to Index](#)

DEBAKEY VASCULAR CLAMPS

Herken Clamps



VC 52125

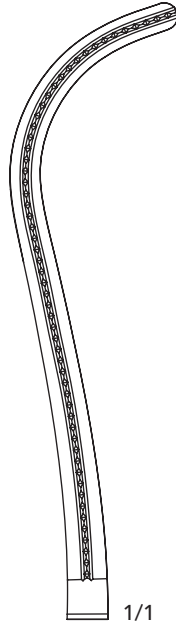

1/1

10" (255 mm)

VC 52225

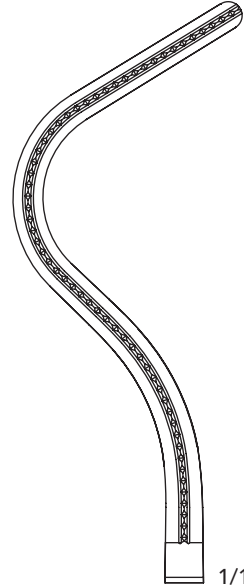

1/1

9 3/4" (250 mm)

VC 52325

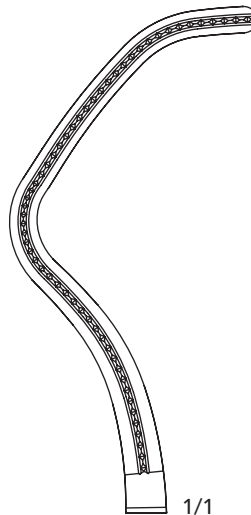

1/1

9 3/4" (250 mm)

VC 52425

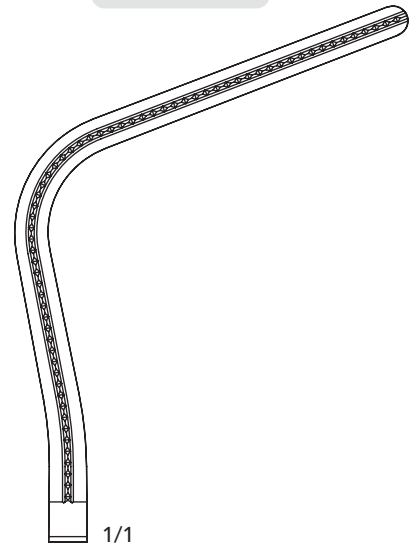

1/1

9 3/4" (250 mm)

Debakey Herken Clamps

[Go to Index](#)

DEBAKEY VASCULAR CLAMPS

Tangential Occlusion Clamps

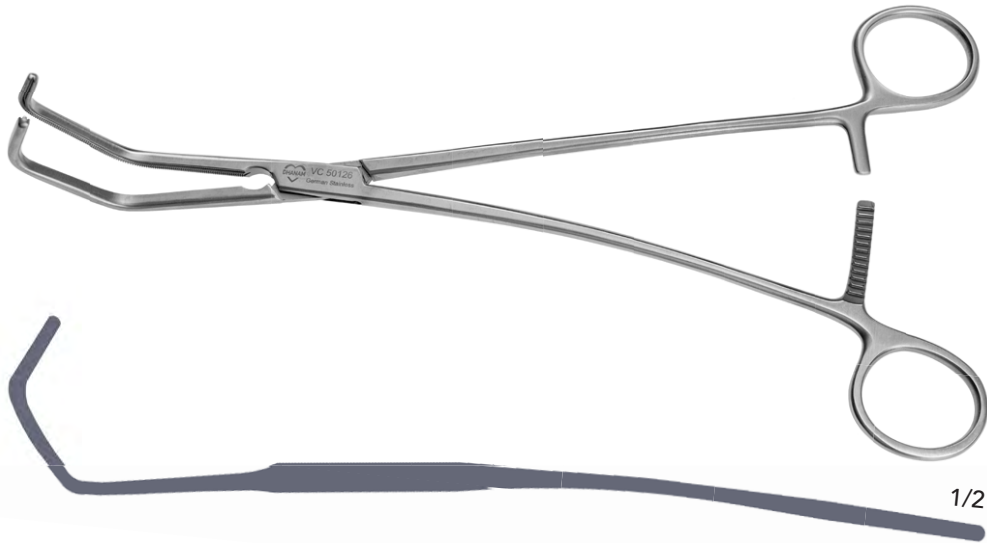

VC 50019

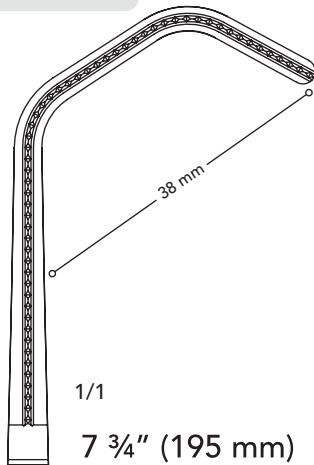

VC 50126

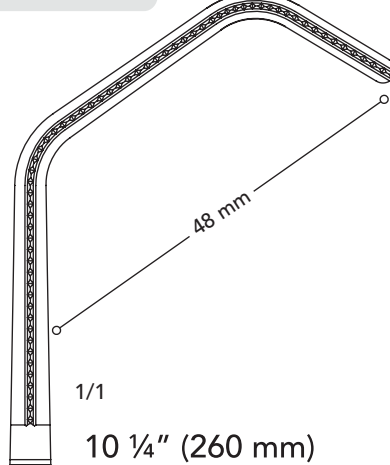

VC 50227

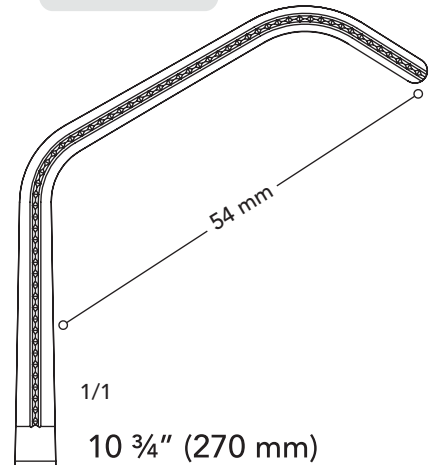

VC 50327

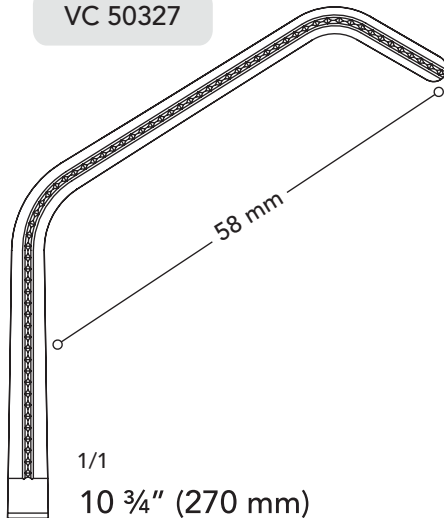

VC 50428

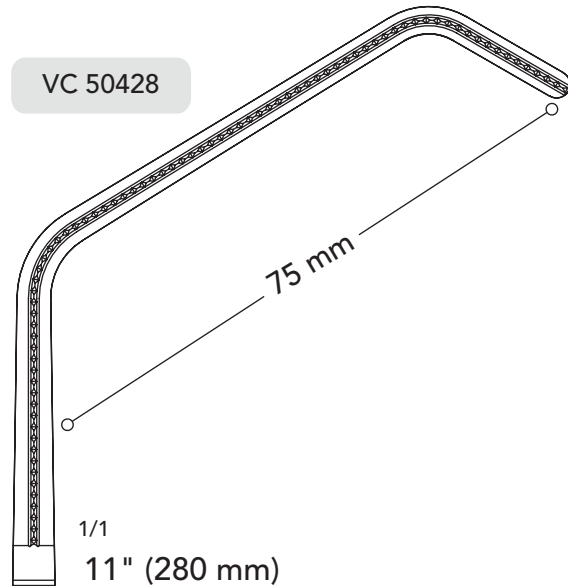

Debakey Tangential Occlusion Clamps

[Go to Index](#)

DEBAKEY VASCULAR CLAMPS

Satinsky Clamps

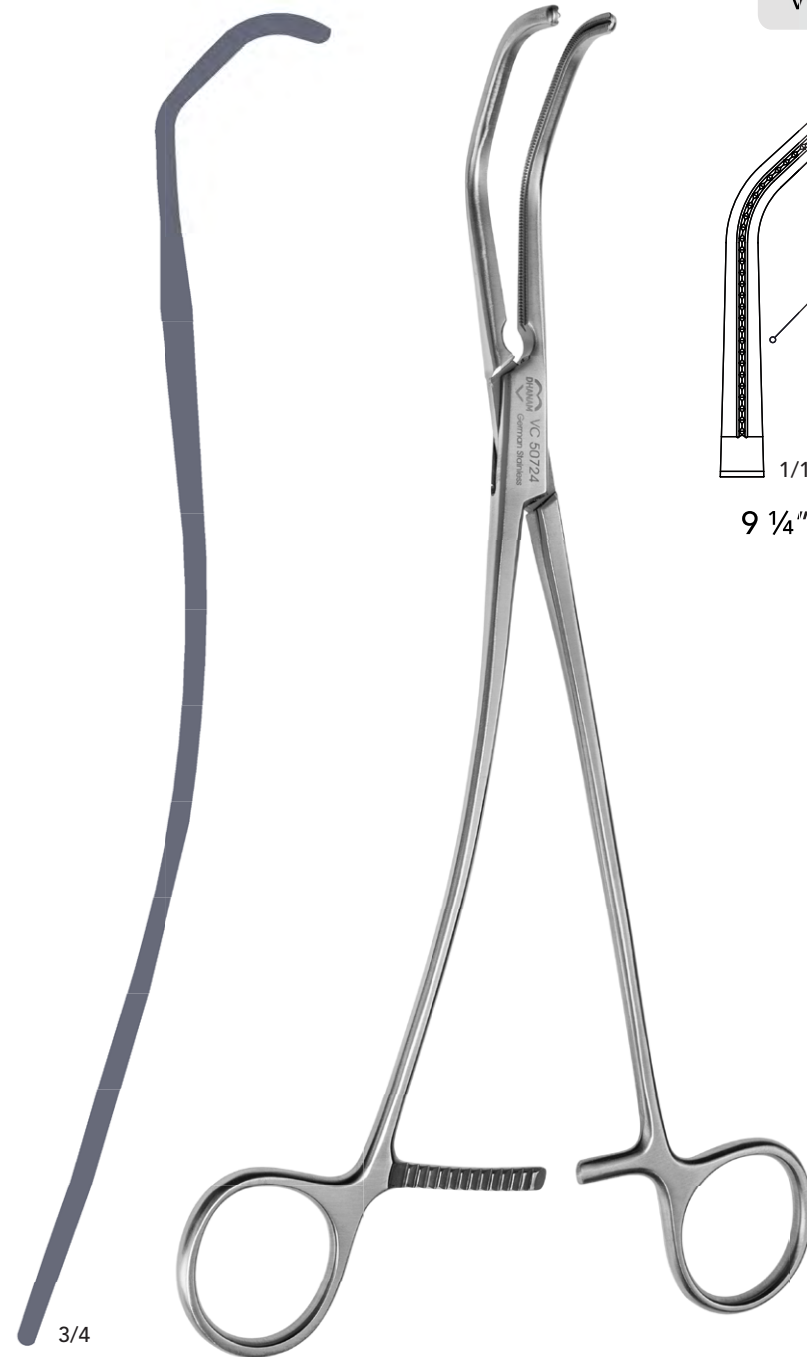

VC 50624

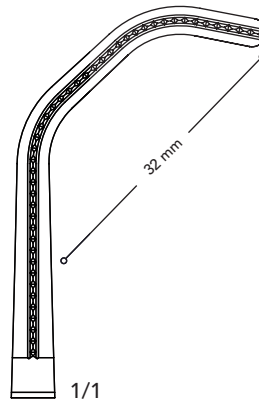

9 1/4" (235 mm)

VC 50724

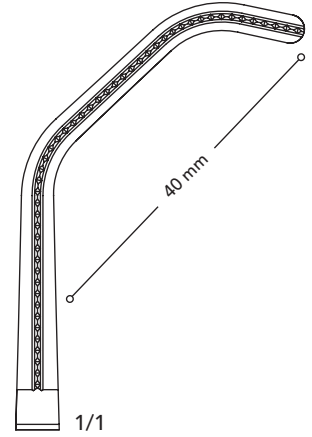

9 1/2" (240 mm)

VC 50824

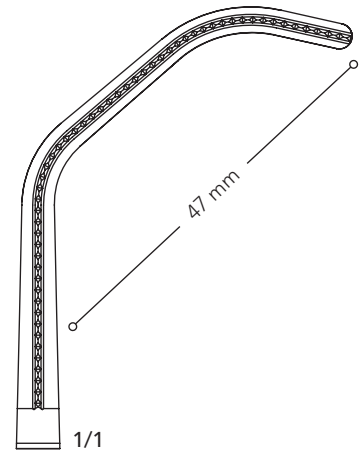

9 1/4" (235 mm)

Debakey Satinsky Clamps

[Go to Index](#)

DEBAKEY VASCULAR CLAMPS

Lambert-Key Clamps



VC 49022

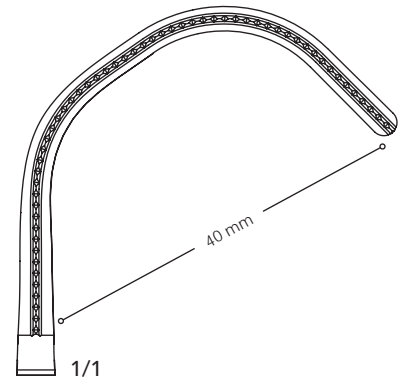

8 1/2" (215 mm)

VC 49125

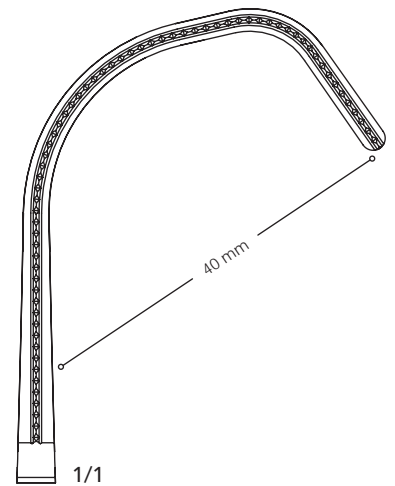

10" (255 mm)

VC 49221

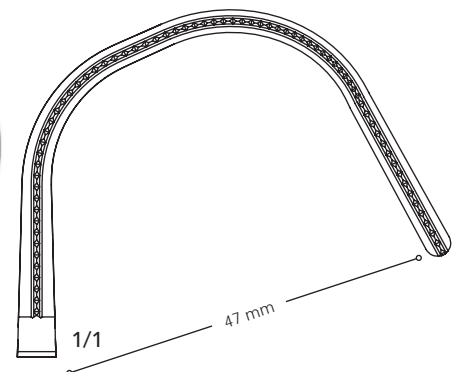

8 1/2" (215 mm)

Debakey Lambert-Key Aorta Anastomosis Clamps

[Go to Index](#)

DEBAKEY VASCULAR CLAMPS

Arota Clamps



VC 52521

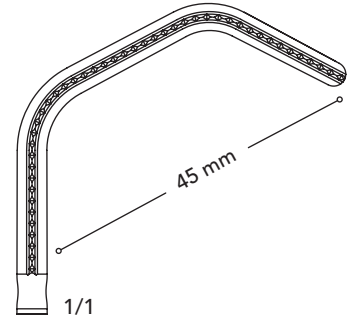

8 1/4" (210 mm)

VC 49526

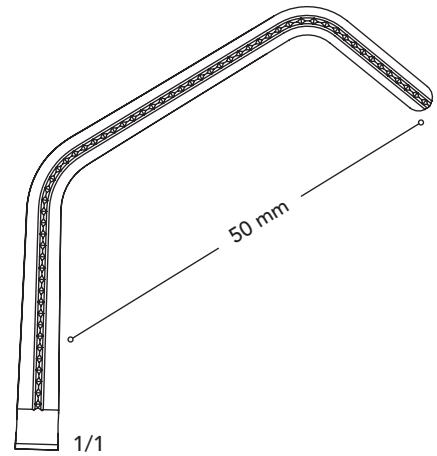

10 1/4" (260 mm)

Debakey Diethrich and Ochsner arota Clamps

DEBAKEY VASCULAR CLAMPS

SEMB Arota Aneurysm Clamps

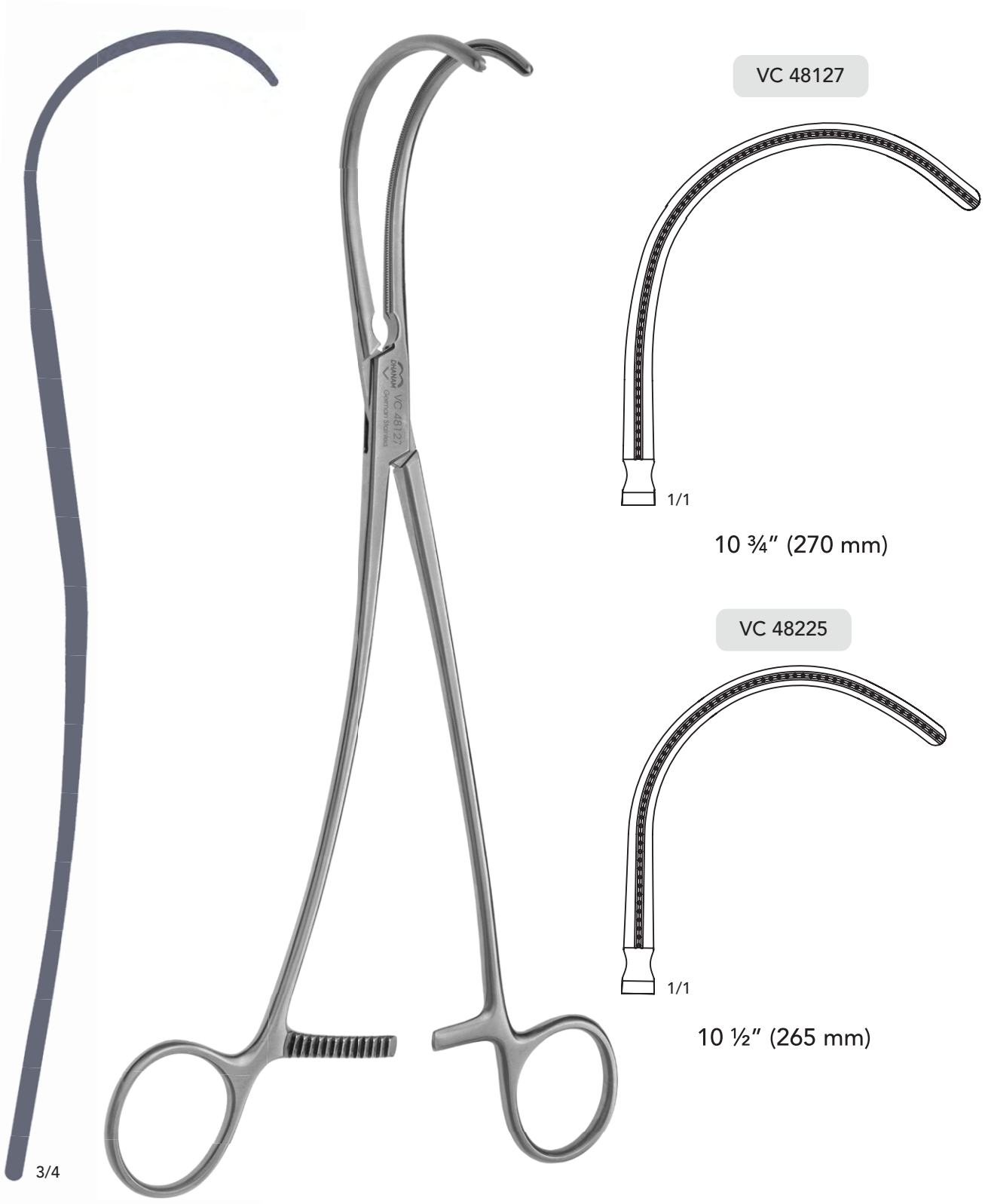

Debakey SEMB Arota Aneurysm Clamps

[Go to Index](#)

DEBAKEY VASCULAR CLAMPS

Aorta Aneurysm Clamps

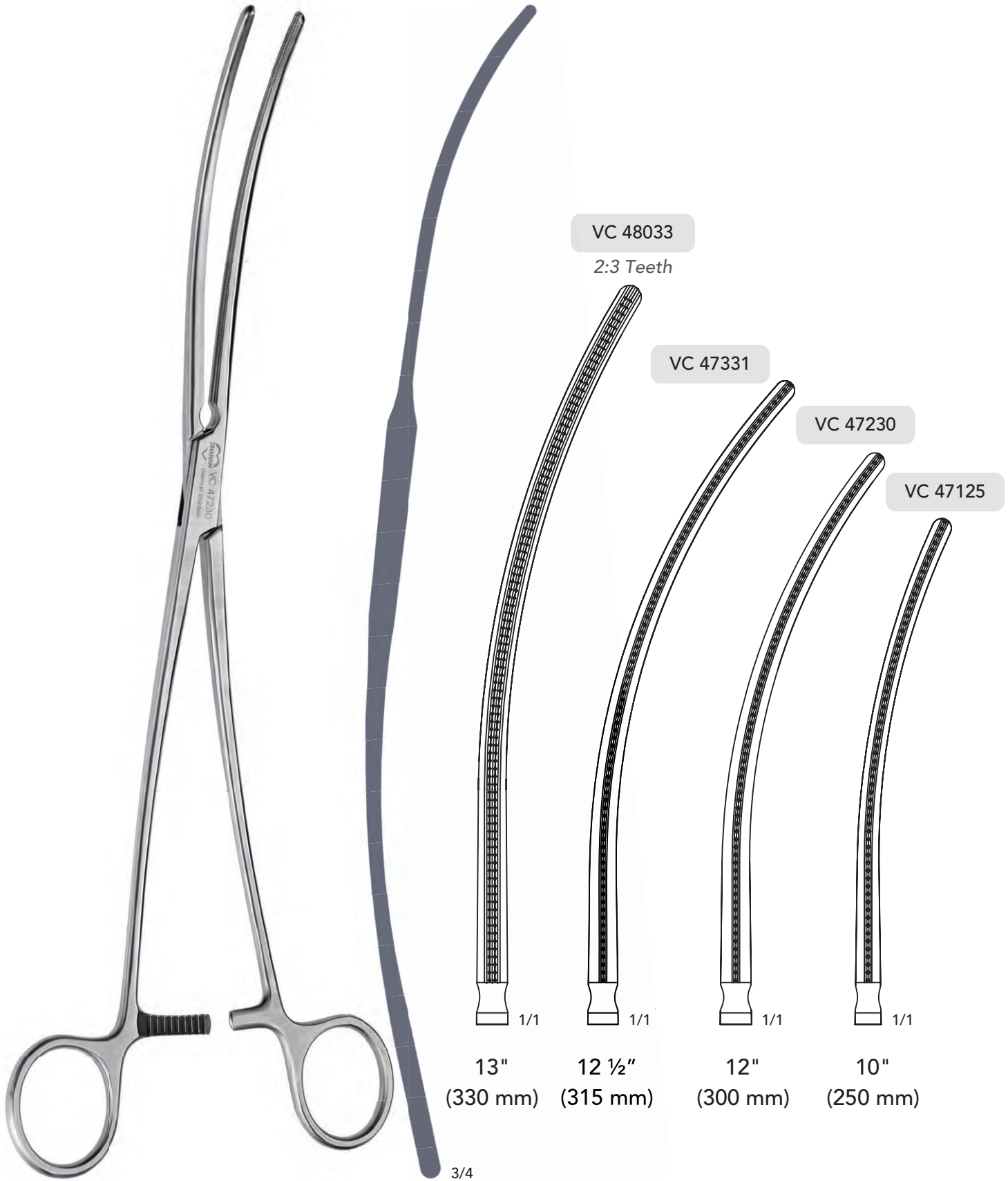

Debakey Aorta Aneurysm Clamps

[Go to Index](#)

DEBAKEY VASCULAR CLAMPS

Straight Clamps

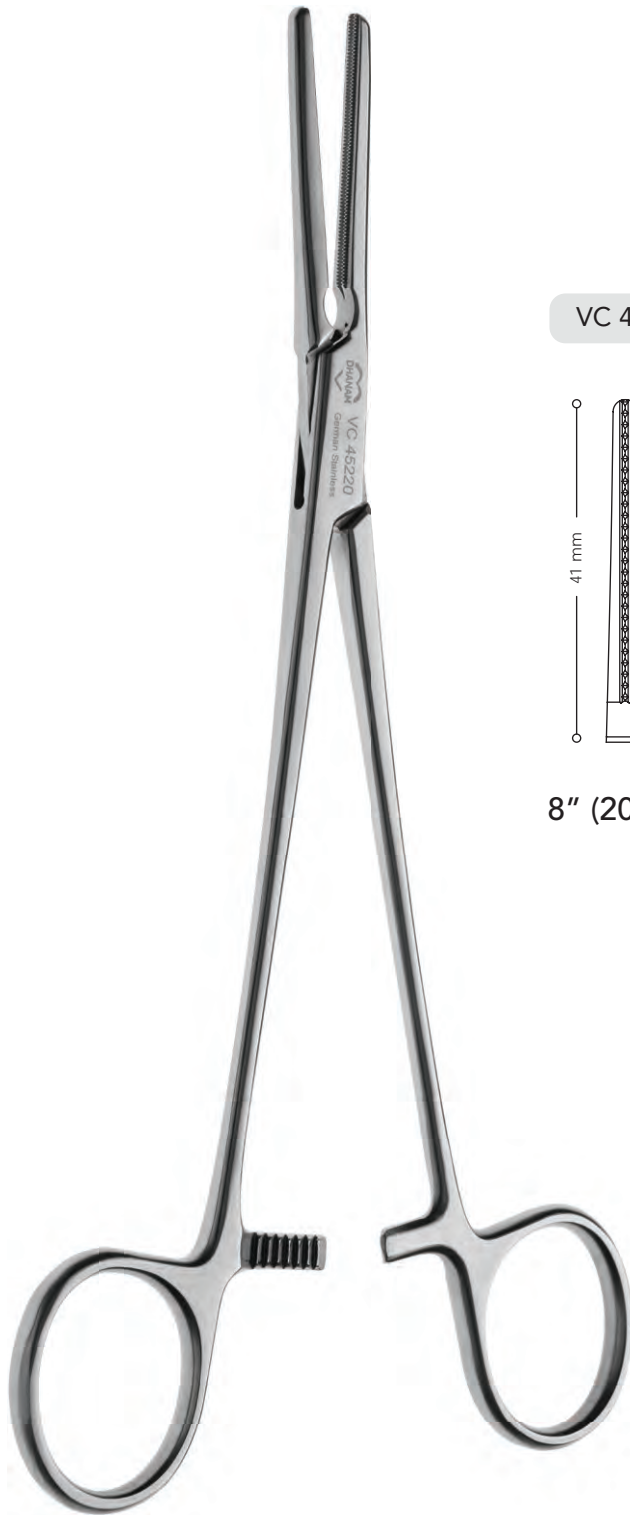

VC 45220

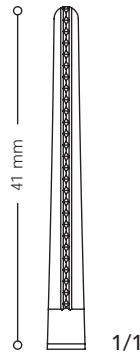

8" (200 mm)

VC 45423

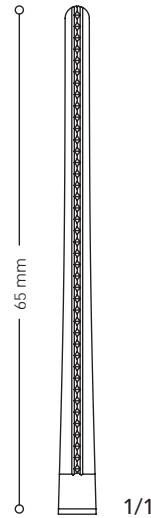

9" (230 mm)

VC 45624

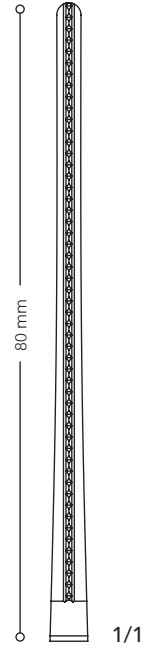

9 1/2" (240 mm)

Debakey Straight Clamps

[Go to Index](#)

DEBAKEY VASCULAR CLAMPS

Cross Clamps

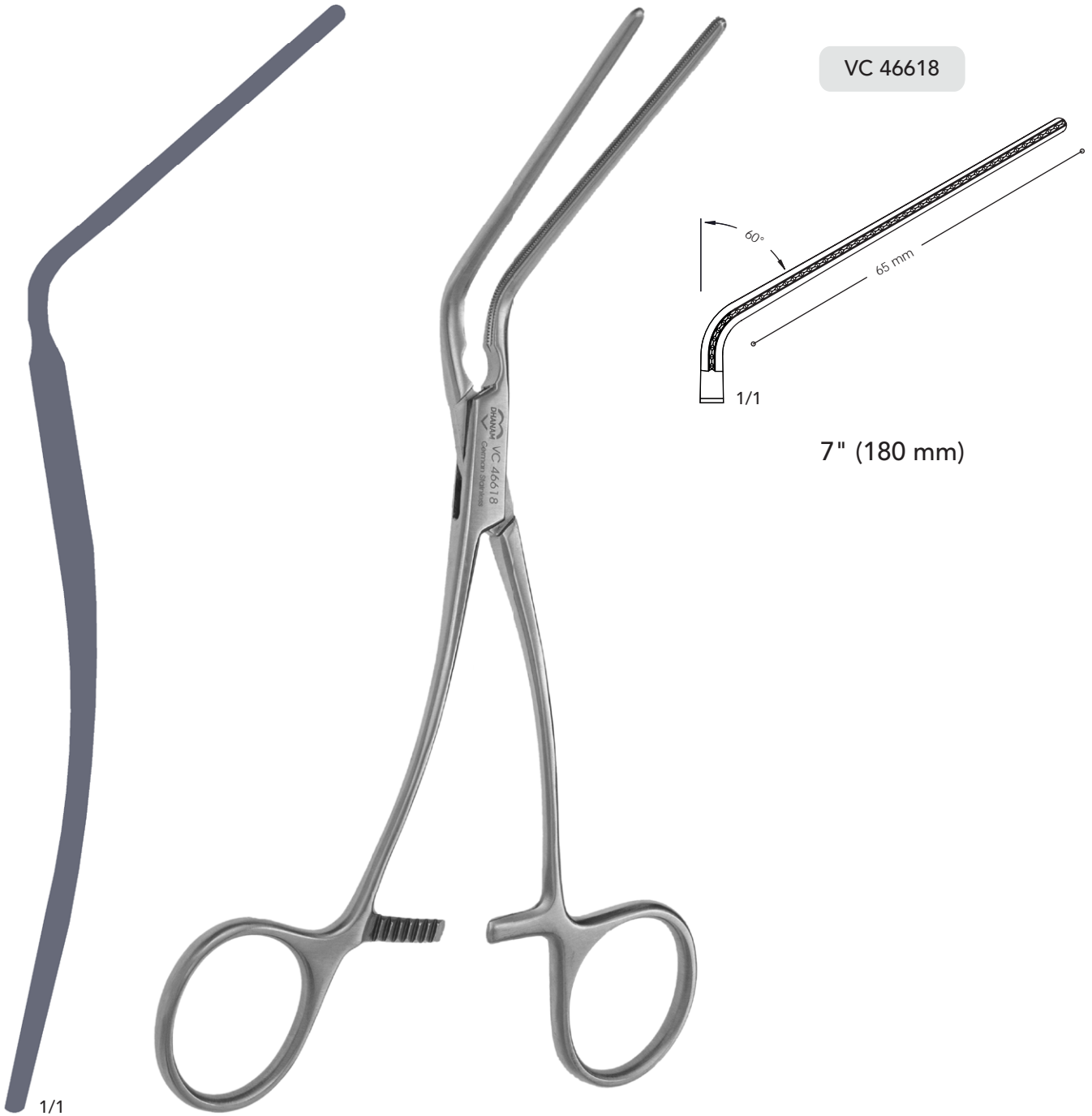

Debakey Cross Clamps

[Go to Index](#)

DEBAKEY VASCULAR CLAMPS

Cross Clamps



VC 46919

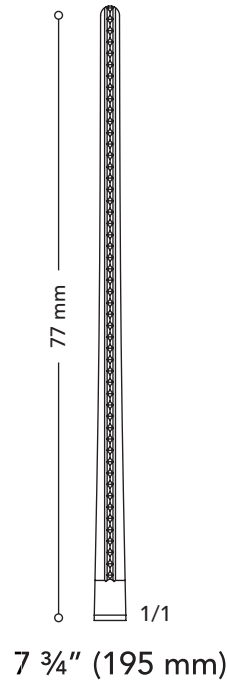

VC 46819

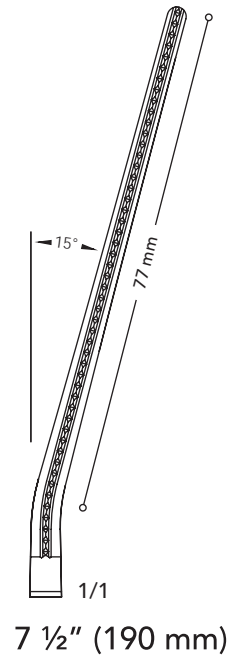

VC 46719

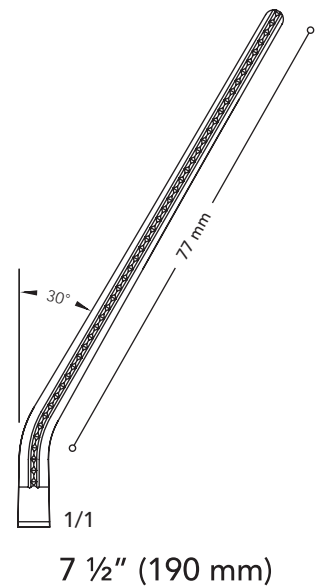

Debakey Leland-Jones Cross Clamps

[Go to Index](#)

DEBAKEY VASCULAR CLAMPS

Cross Clamps

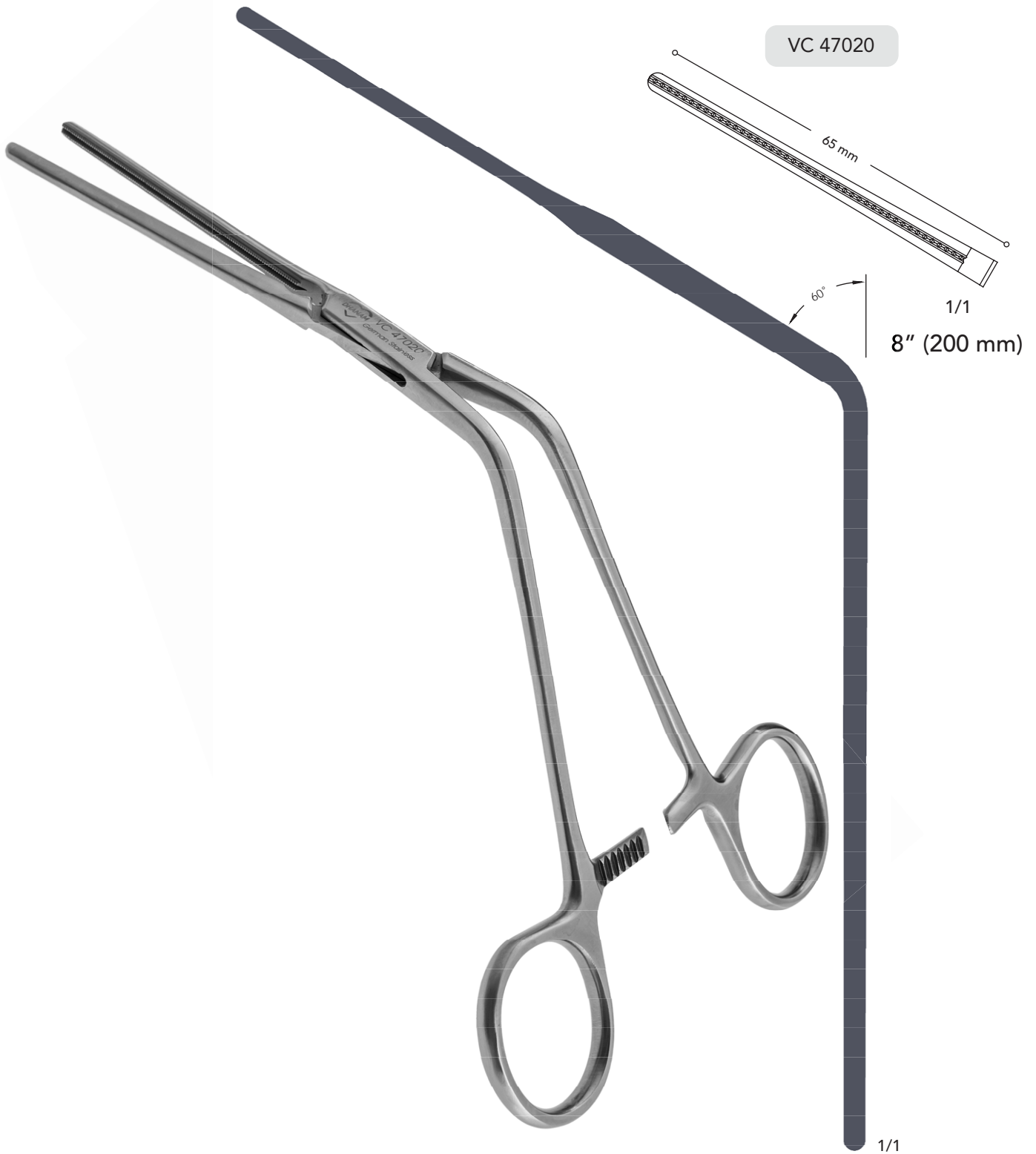

Debakey ILIACA Cross Clamp

[Go to Index](#)

DEBAKEY VASCULAR CLAMPS

Cross Clamps

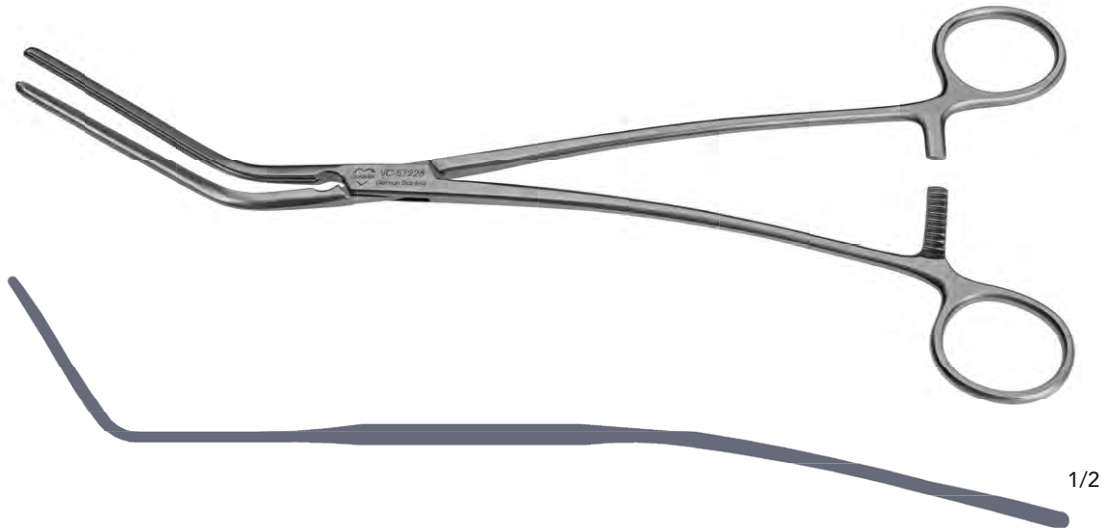

VC 51330

VC 51228

VC 51123

VC 51024

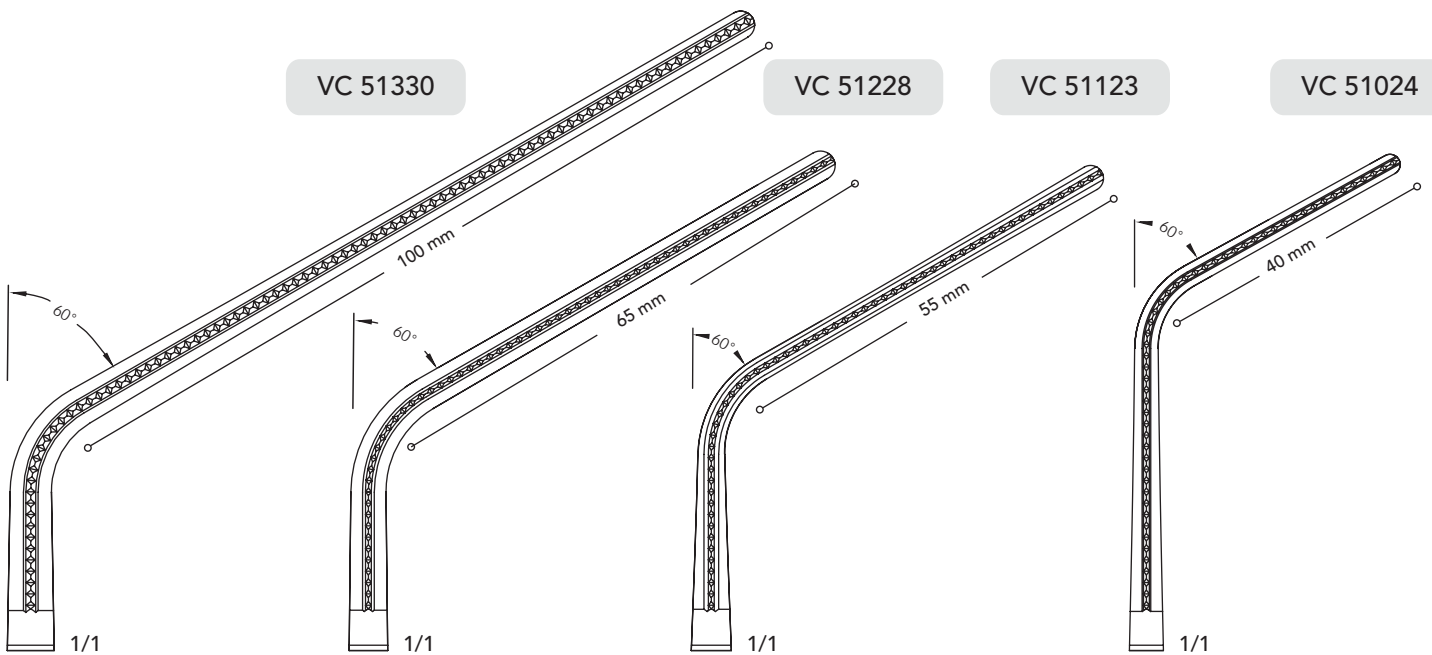

12" (300 mm)

11" (280 mm)

9" (230 mm)

9 1/2" (240 mm)

Debakey Multi Purpose Angled Cross Clamps

[Go to Index](#)

DEBAKEY VASCULAR CLAMPS

Cross Clamps



VC 51827

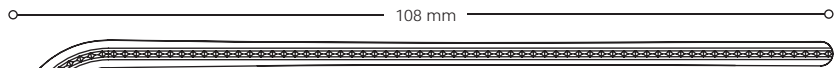

VC 51725

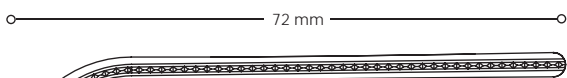

10 3/4" (270 mm)

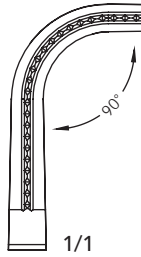

10" (250 mm)

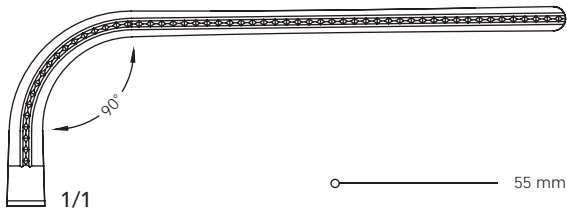

VC 51621

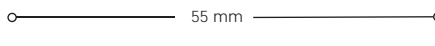

8 1/4" (210 mm)

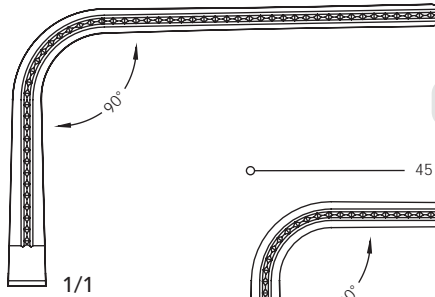

VC 51523

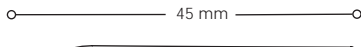

9" (230 mm)

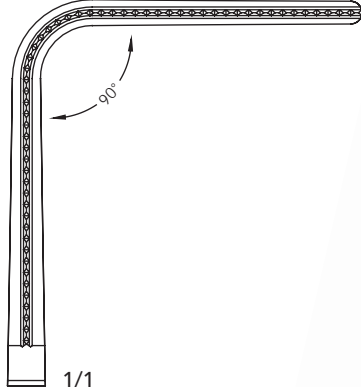

Debakey Multi Purpose Right Angled 90° Cross Clamps

[Go to Index](#)

DEBAKEY VASCULAR CLAMPS

Cross Clamps



VC 49320

2:3 Teeth

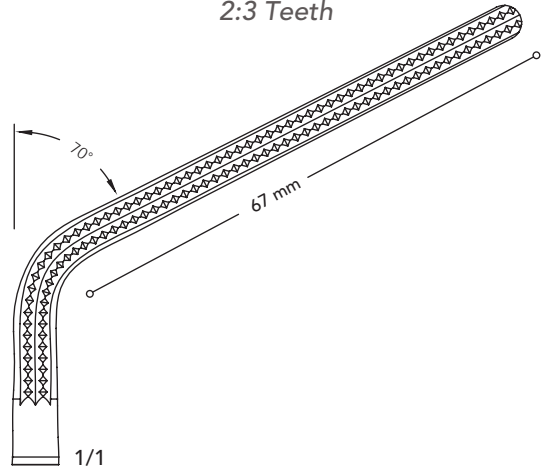

8" (200 mm)

VC 49423

2:3 Teeth

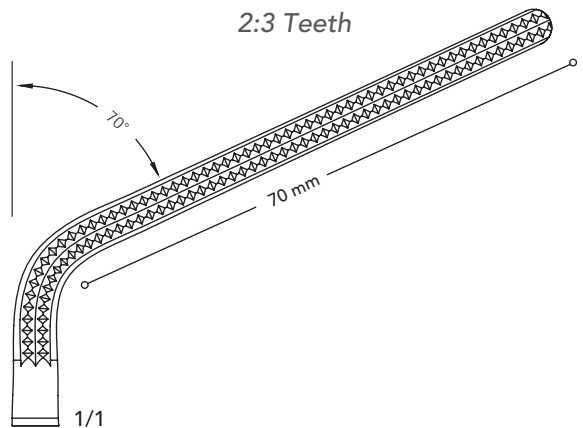

9" (230 mm)

Debakey Cross Clamps
(2:3 Teeth)

[Go to Index](#)

VASCULAR CLAMPS

Price – Thomas Clamp



VC 95022

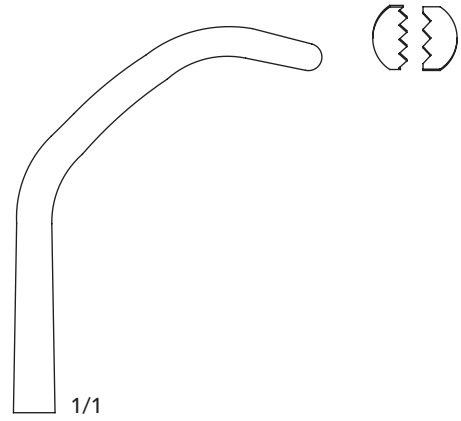

9" (220 mm)

Price - Thomas Vascular Clamps 9"

[Go to Index](#)

TITANIUM MICRO CLAMPS

Debakey Straight Clamp



VC 61012



4 3/4" (120 mm)

Titanium Debakey Micro Clamp
(Straight Shank)

TITANIUM MICRO CLAMPS

Debakey Side Biting Angled Clamps



VC 61611

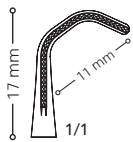

4" (100 mm)

VC 62012

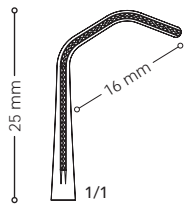

4 1/8" (105 mm)

VC 63612

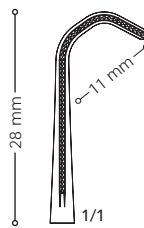

4 1/4" (110 mm)

VC 63712

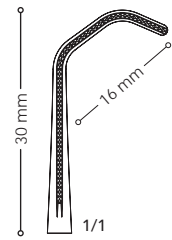

4 1/4" (110 mm)

Titanium Debakey Side Biting Micro Clamps (Angled Shanks)

[Go to Index](#)

TITANIUM MICRO CLAMPS

Debakey Angled Clamps



VC 61312

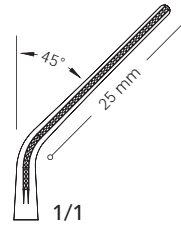

4 ¼" (110 mm)

VC 63312

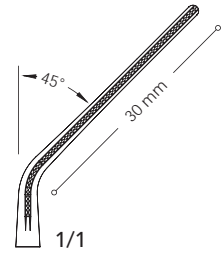

4 ½" (115 mm)

VC 61412

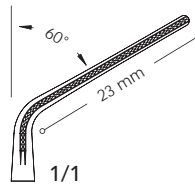

4 ⅛" (105 mm)

VC 63411

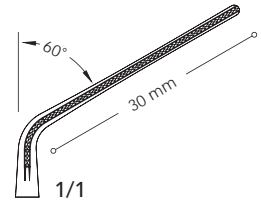

4 ¼" (110 mm)

VC 61512

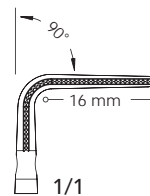

4" (100 mm)

VC 63512

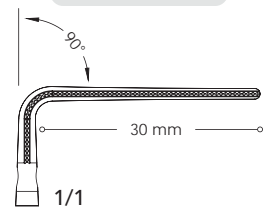

4" (100 mm)

Titanium Debakey Angled Micro Clamps
(Straight Shanks)

[Go to Index](#)



MICS INSTRUMENTS

CHAPTER - 03

[Go to Index](#)

MICS INSTRUMENTS

Intercostal Base Retractor

1001



MICS Intercostal Base Retractor

1002



35 x 40 mm Blade

1003



35 x 50 mm Blade

1004



35 x 60 mm Blade

[Go to Index](#)

MICS INSTRUMENTS

IMA Retractor Arc and Coupler Set

2001



Arc Top Part

2004



Coupler Set

2002



Arc Side Parts (Pair)

2005



70 x 70 mm - IMA Blade Small

2006



70 x 90 mm - IMA Blade Big

2003

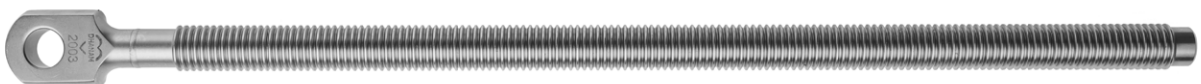

Puller Rod

[Go to Index](#)

MICS INSTRUMENTS

LA Attachment Set

5001



LA Ball Adapter

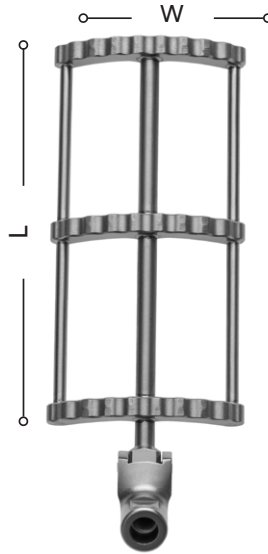

Code No	Size (L x W)
5101	45 x 30 mm
5102	60 x 30 mm
5103	45 x 45 mm
5104	60 x 45 mm

Atrial Blades

5002



LA Ball Adapter extender

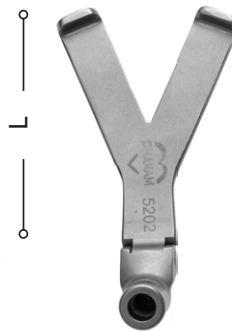

Code No	Size (L)
5201	30 mm
5202	40 mm
5203	50 mm
5204	60 mm
5205	70 mm

Atrial Hooks

5003



LA Blade Lifter

5004

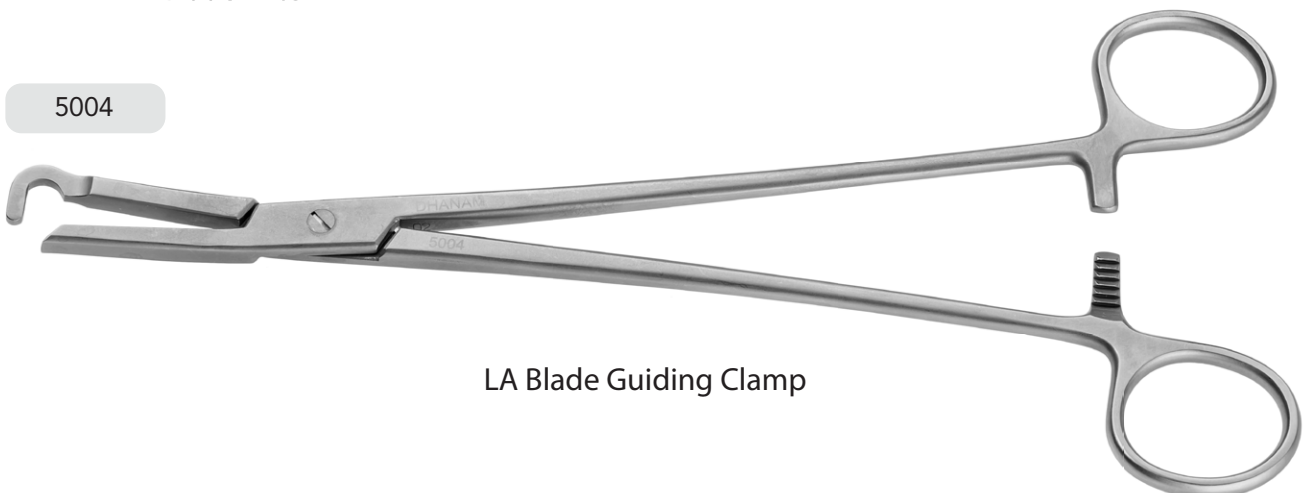

LA Blade Guiding Clamp

[Go to Index](#)

3001



3002

(35 x 30 mm)



3003

(35 x 40 mm)



3004

(35 x 50 mm)



Mini-Sternotomy and Mini-Thoracotomy
Retractor

[Go to Index](#)

MICS INSTRUMENTS

Long Valve Forceps

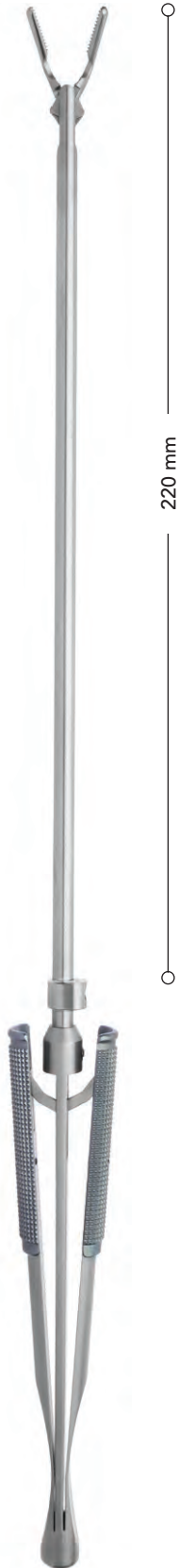

13 3/4", 350 mm



11", 280 mm

3005
(350 mm Long)

3005-S
(280 mm Long)

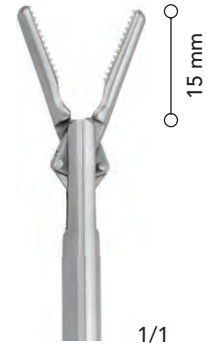

3006
(350 mm Long)

3006-S
(280 mm Long)



MICS Long Shaft Valve Forceps,
2.8 mm Jaws

[Go to Index](#)



170 mm

11 3/4", 300 mm

3008



15 mm

1/1

Straight

3007



1/1

Angled

MICS Long Shaft Fine Valve Forceps,
1.5 mm Jaws

MICS INSTRUMENTS

Clip Applicators

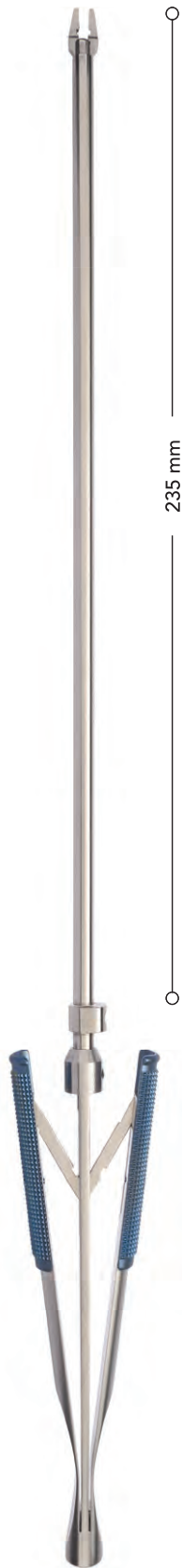

235 mm

4001



1/1

Small (Yellow)



235 mm

4002



1/1

Medium (Blue)

MICS Long Clip Applicator for "Horizon Clip"™, 14 1/2" 365 mm

[Go to Index](#)

6001

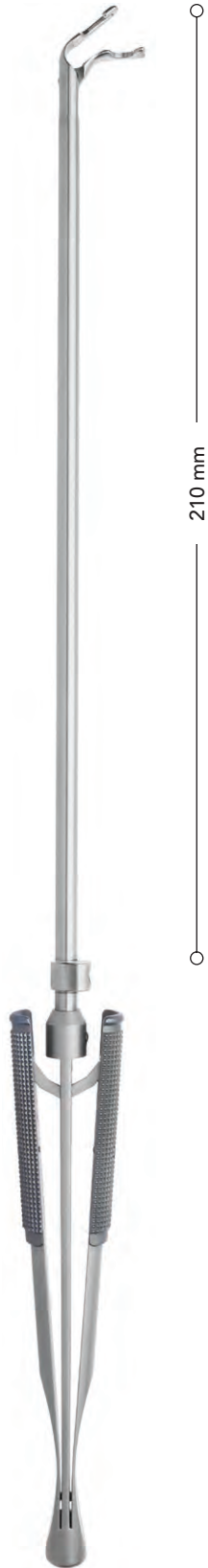

13 1/2", 340 mm

6002



11", 280 mm

Movable Jaws



MICS Long Knot Pushers
(Jaw Movable Type)

[Go to Index](#)

8001



240 mm

13 1/2", 340 mm

8002



190 mm

11 1/2", 290 mm

Fixed Tip



1/1

MICS Long Knot Pushers (Fixed Tip)

[Go to Index](#)

MICS INSTRUMENTS

Chitwood Debakey Clamps

9002

1:2 Teeth

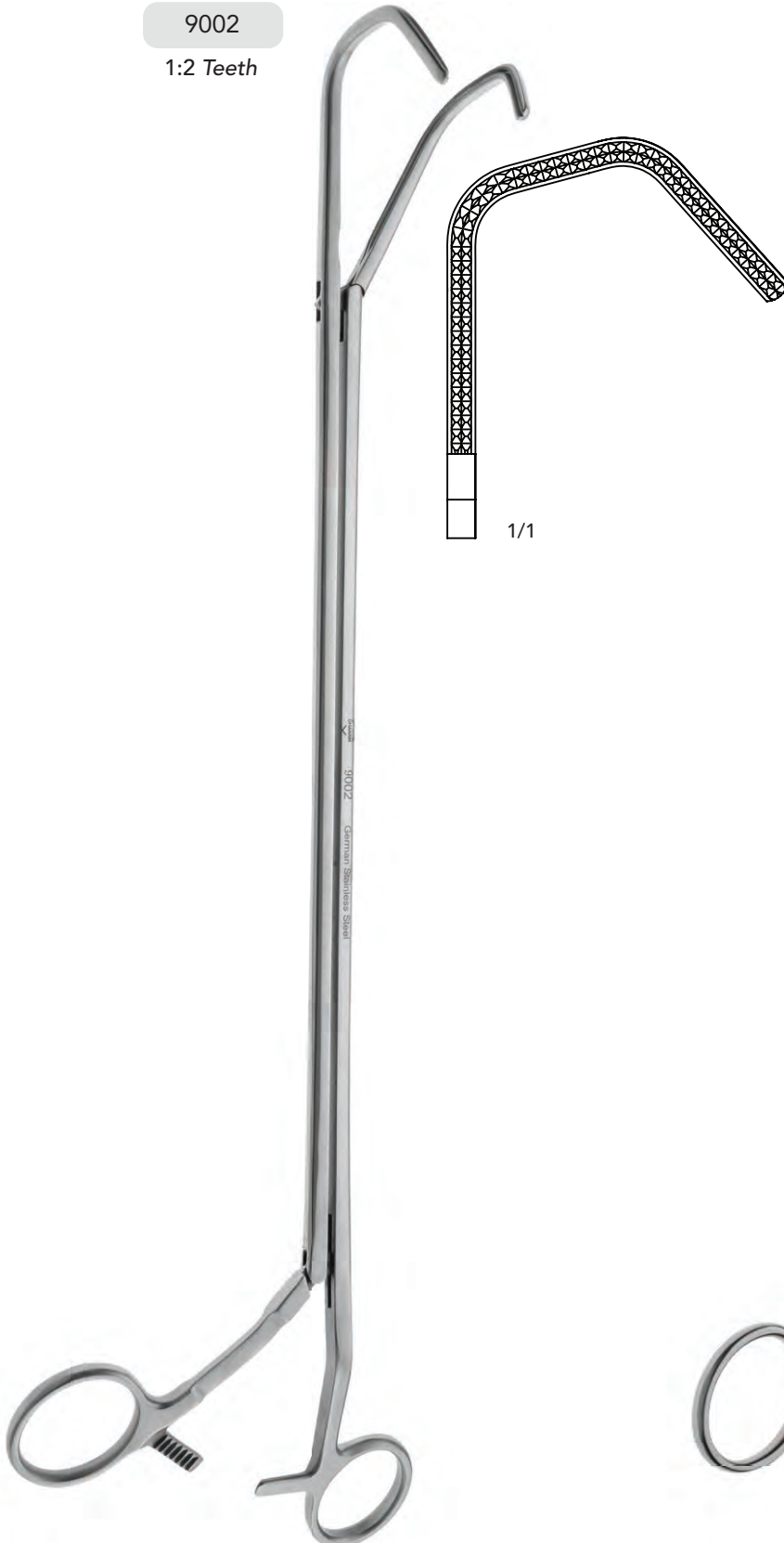

13 3/4", 350 mm

Chitwood Debakey Satinsky Clamp,
(2.8 mm Jaws)

9001

2:3 Teeth

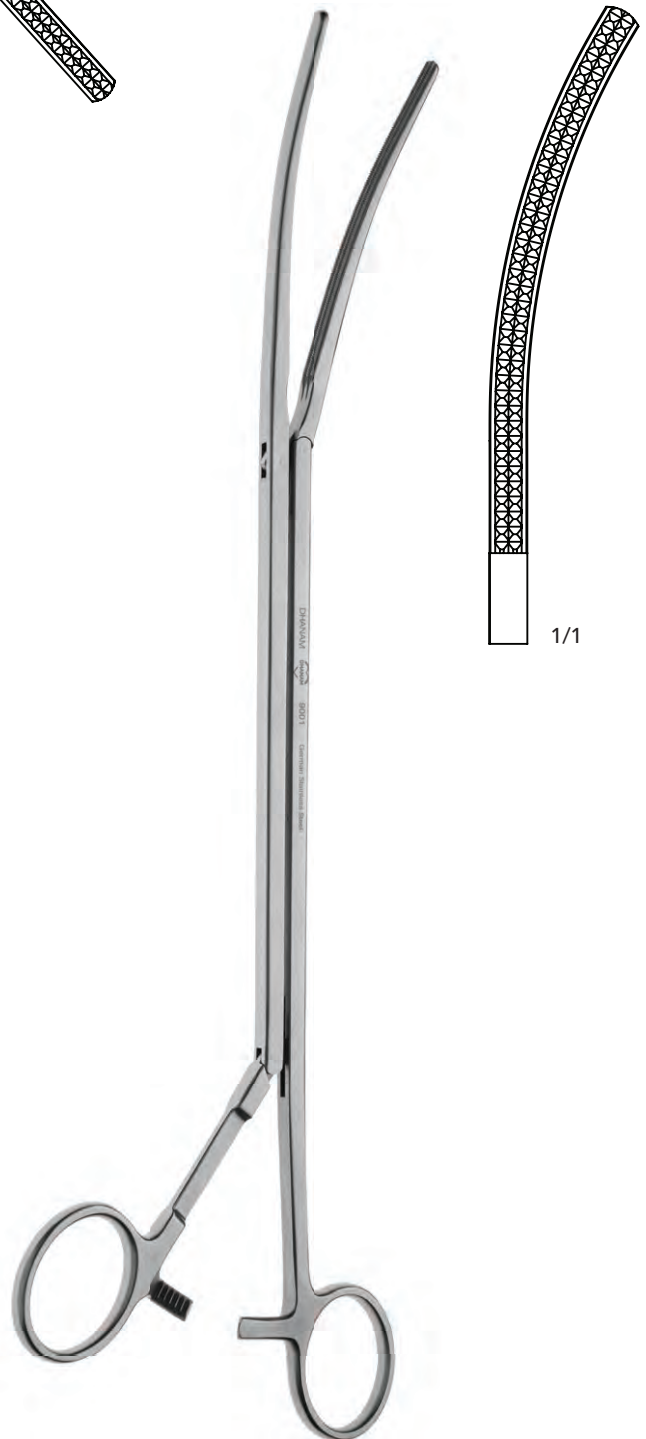

11 1/2", 290 mm

Chitwood Debakey Clamp,
(2.8 mm Jaws)

[Go to Index](#)

MICS INSTRUMENTS

Nerve Hooks



8006



13 1/2", 340 mm

8007



11", 280 mm



1/1

MICS Long Nerve Hooks

[Go to Index](#)

MICS INSTRUMENTS

Cardiotomy Suckers

7008



16", 400 mm

MICS Rough Sucker, (8 mm Tip)

7007



14", 360 mm

MICS Cardiotomy Sucker, (6 mm Tip)

[Go to Index](#)

PTE INSTRUMENTS

CHAPTER - 04



[Go to Index](#)

PTE INSTRUMENTS

Madani Debakey Forceps

7001

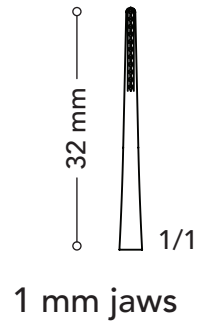
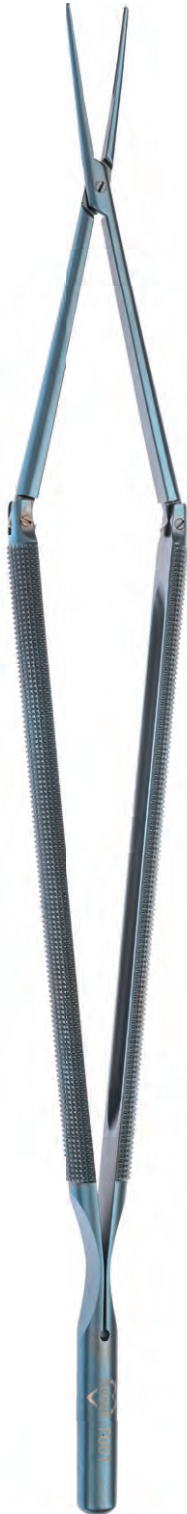

7002

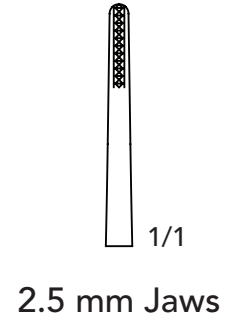

PTE (Madani) Debakey Forceps 12", 305 mm
(Titanium)

[Go to Index](#)

PTE INSTRUMENTS

Pulmonary Endarterectomy Dissectors

8003



3/4

Straight

8004



3/4

Curved

8005



3/4

Angled

Pulmonary Endarterectomy Dissectors, 10 $\frac{3}{4}$ " 270 mm

[Go to Index](#)

GENERAL INSTRUMENTS

CHAPTER - 05

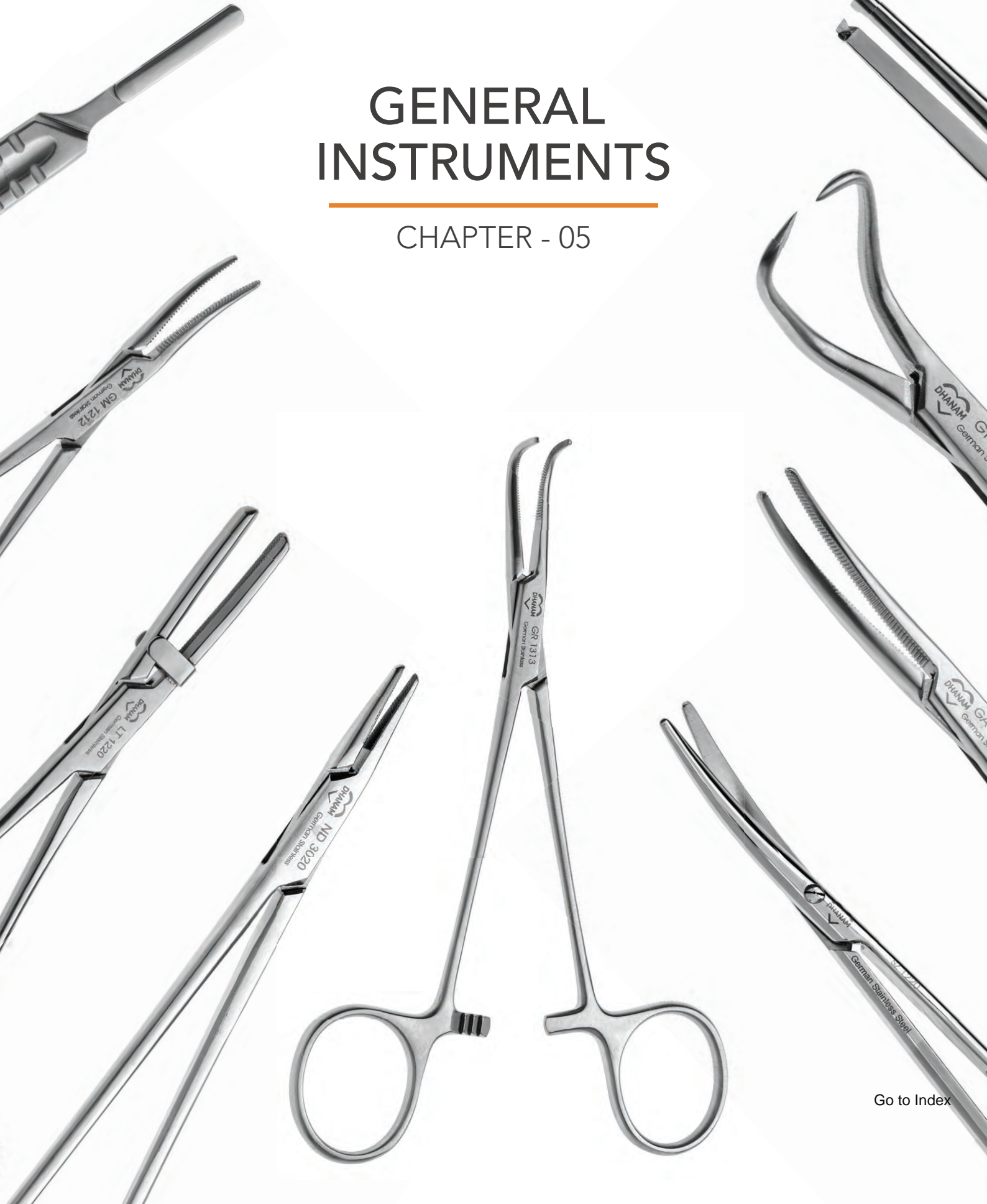

[Go to Index](#)

GENERAL INSTRUMENTS

BP Handles



BP Handles

[Go to Index](#)

GENERAL INSTRUMENTS

BP Handles

BP 0715



1/1

Size 7, 6 3/4"

BP Handles

BP 0723



1/1

Size 7L, 9"

[Go to Index](#)

GENERAL INSTRUMENTS

Forceps

GM 1110

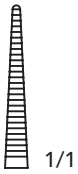

4" (100 mm)

GM 1210

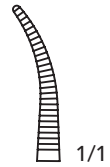

4" (100 mm)



Baby Mosquito Forceps

GM 1112

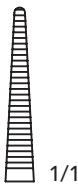

5" (125 mm)

GM 1212

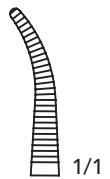

5" (125 mm)



Mosquito Forceps

[Go to Index](#)

GC 1113

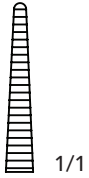

5 ¼" (135 mm)

GC 1213

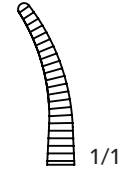

5 ¼" (135 mm)

GC 1114

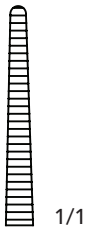

5 ½" (140 mm)

GC 1214

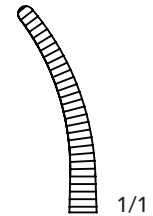

5 ½" (140 mm)



Crile Forceps

GENERAL INSTRUMENTS

Forceps

GA 1115

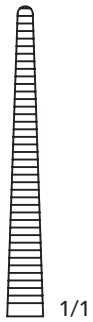

6" (150 mm)

GA 1215

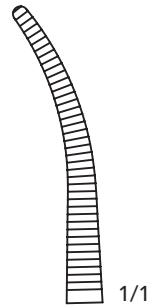

6" (150 mm)



Artery Forceps

[Go to Index](#)

GA 1120

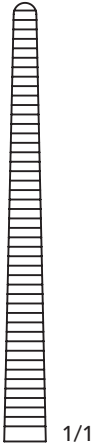

1/1

8" (200 mm)

GA 1220

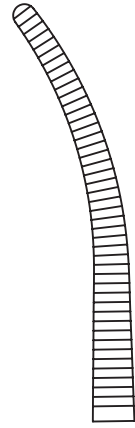

1/1

8" (200 mm)

GA 1223



1/1

9" (230 mm)

GA 1225

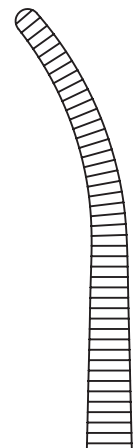

1/1

10" (255 mm)



Artery Forceps

GENERAL INSTRUMENTS

Forceps

GK 2115

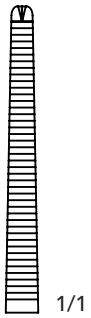

6" (150 mm)

GK 2120

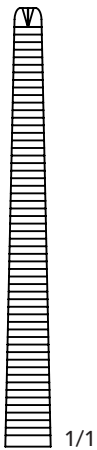

8" (200 mm)

GK 2215

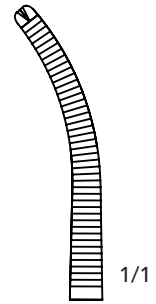

6" (150 mm)

GK 2220

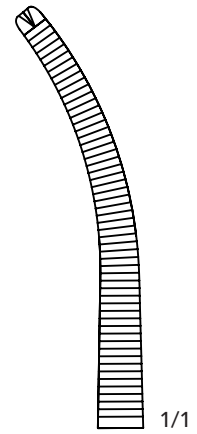

8" (200 mm)



Kocher Forceps

[Go to Index](#)

GL 3015

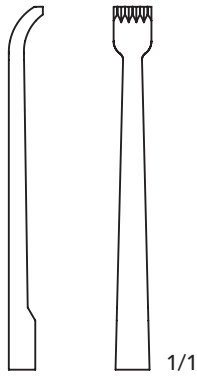

6" (150 mm)

GL 3020

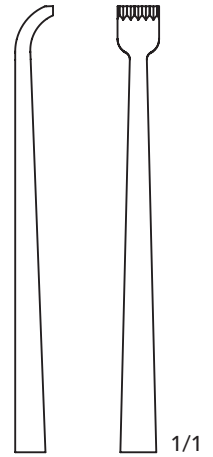

8" (200 mm)



Allis Forceps

GENERAL INSTRUMENTS

Forceps



Babcock Forceps

[Go to Index](#)

GT 5010

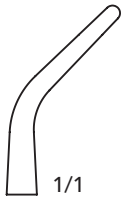

4" (100 mm)

GT 5012

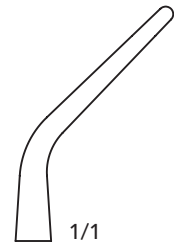

5" (125mm)



Towel Clip Forceps (Backhaus)

GENERAL INSTRUMENTS

Forceps



Code No	Ring Size	For Tube Size of
GT 5112	1/4" (8 mm)	3/16" (5 mm)
GT 5212	3/8" (11 mm)	5/16" (8 mm)
GT 5312	1/2" (13 mm)	7/16" (11 mm)
GT 5412	5/8" (16 mm)	9/16" (14.5 mm)

Morse Towel Clip 5" with Tubing Holders

GE 1215

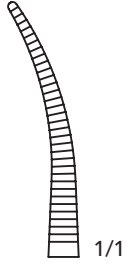

6" (150 mm)

GE 1220

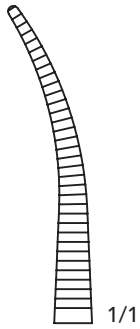

8" (200 mm)

GE 1225

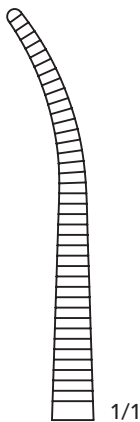

10" (255 mm)

GE 1218

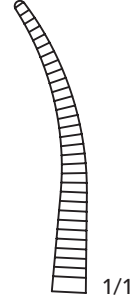

7" (175 mm)

GE 1223

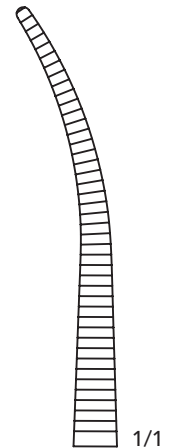

9" (225 mm)



Kellies Artery Forceps

[Go to Index](#)

GENERAL INSTRUMENTS

Forceps

GE 1315

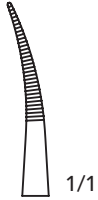

6" (150 mm)

GE 1317

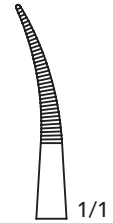

7" (175mm)

GE 1320

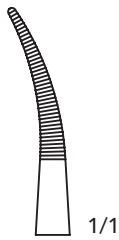

8" (200 mm)



Kellies Artery Forceps Fine "Paediatric"

[Go to Index](#)

GR 1113

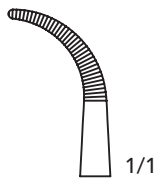

5 1/2" (140 mm)

GR 1313

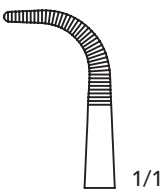

5 1/2" (140 mm)

GR 1217

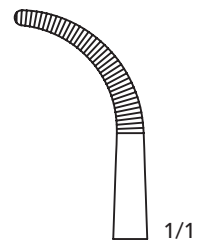

7" (175 mm)

GR 1417

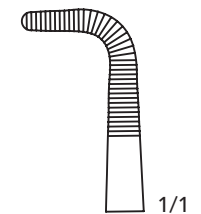

7" (175 mm)



Right Angle Forceps Fine "Paediatric"

GR 7018

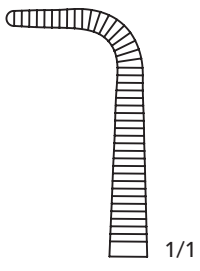

7" (175 mm)

GR 7023

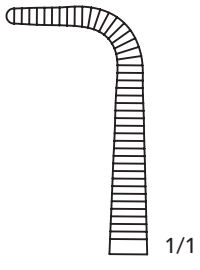

9" (225 mm)

GR 7020

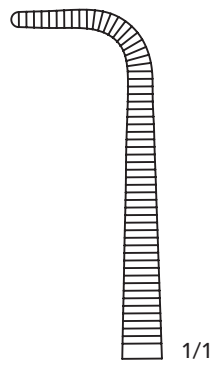

8" (200 mm)

GR 7025

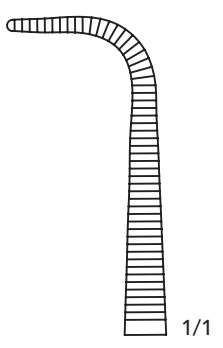

10" (255 mm)



Right Angle Forceps STD

[Go to Index](#)

GO 8215

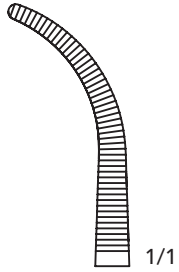

6" (150 mm)

GO 8218

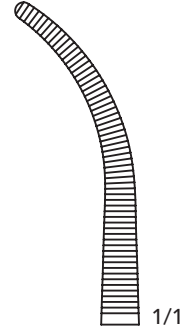

7" (175 mm)

GO 8220

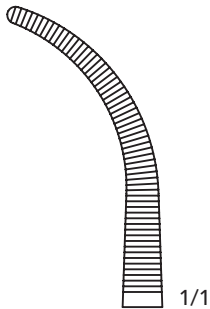

8" (200 mm)

GO 8223

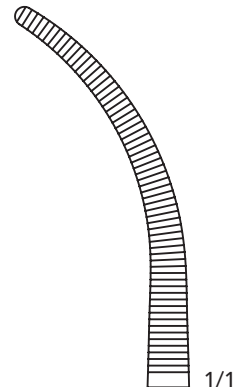

9" (225 mm)

GO 8225

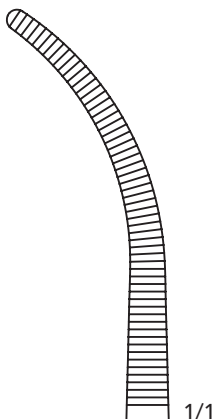

10" (255 mm)



Robert Artery Forceps

[Go to Index](#)

GENERAL INSTRUMENTS

Forceps

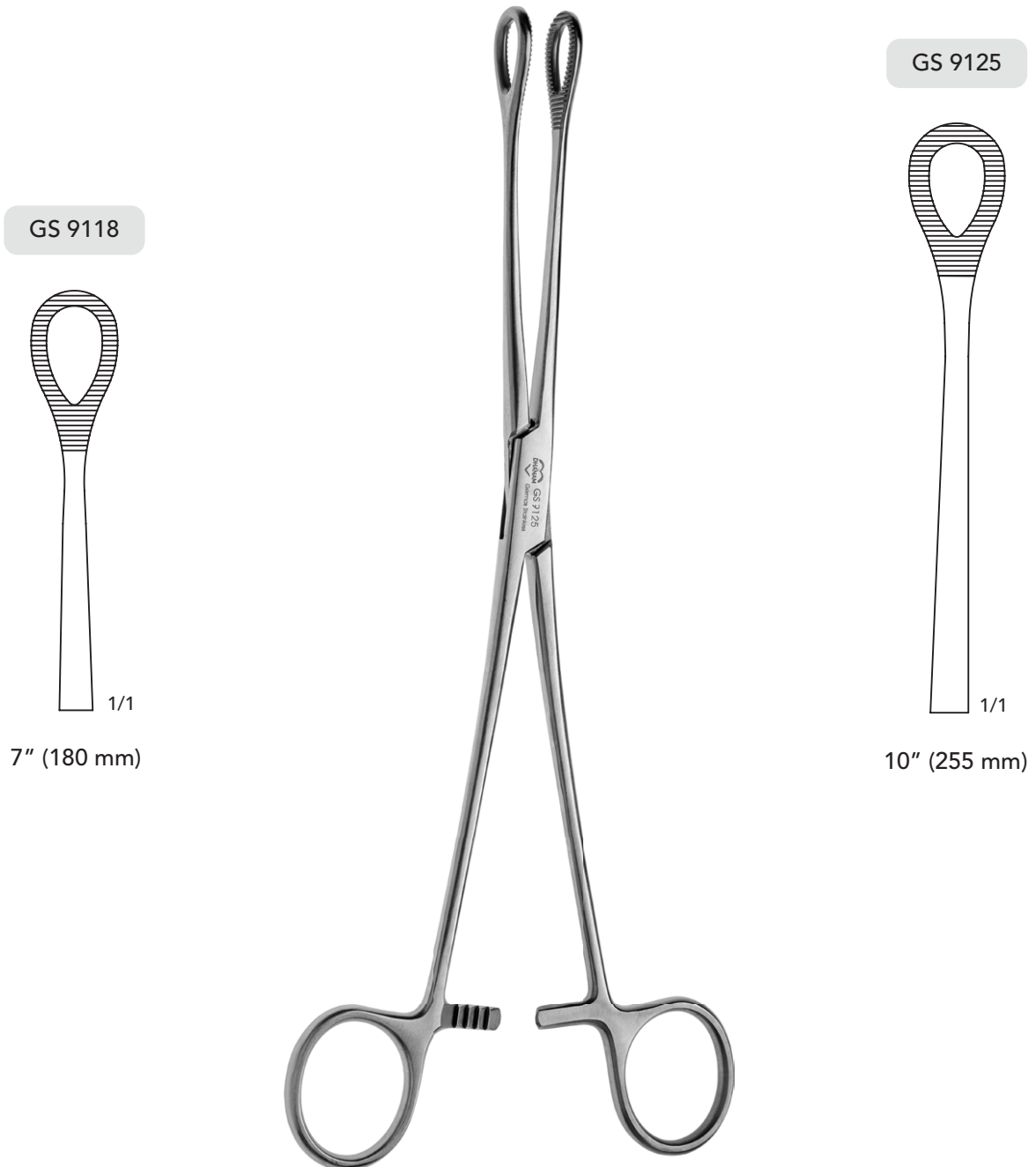

Sponge Holding Forceps

[Go to Index](#)

GD 0123

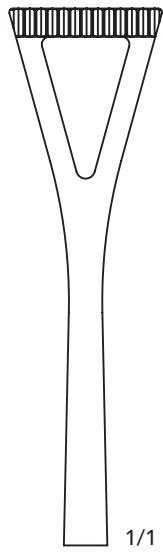

9" (230 mm)



Duval Lung Forceps

GENERAL INSTRUMENTS

Forceps

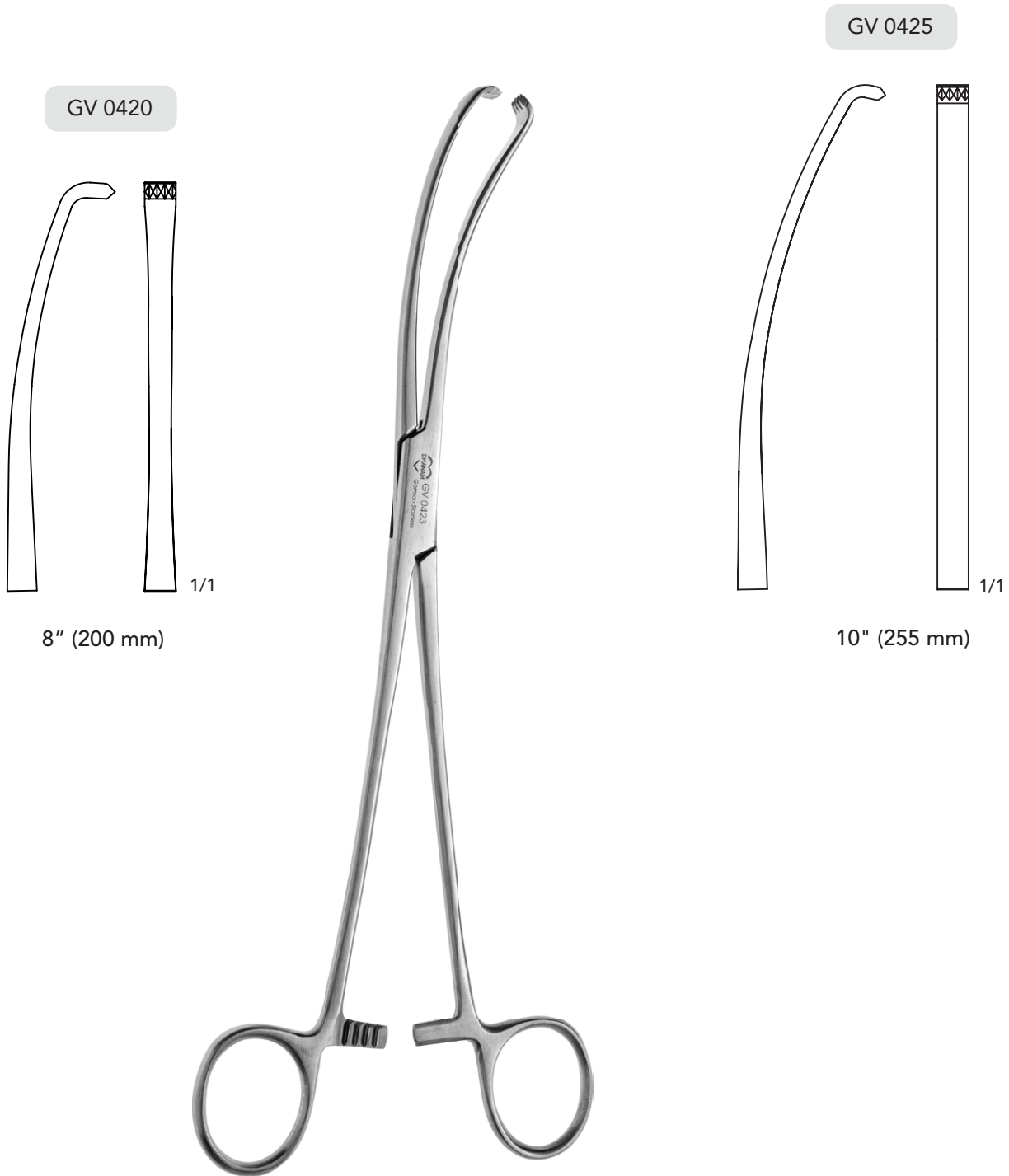

Vulsellum Forceps

[Go to Index](#)

SZ 1115



6" (150 mm)

SZ 1117

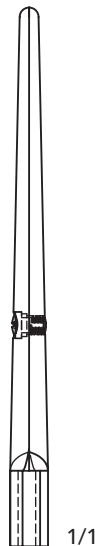

7" (175 mm)

SZ 1215

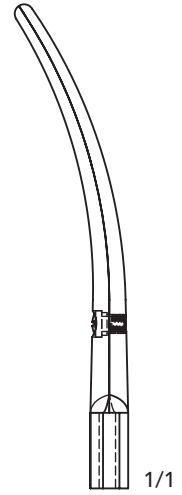

6" (150 mm)

SZ 1217

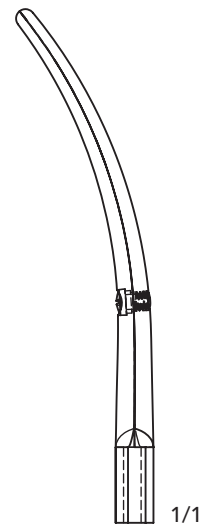

7" (175 mm)



Metzenbaum Scissors

[Go to Index](#)

GENERAL INSTRUMENTS

Scissors

SZ 1120



8" (200 mm)

SZ 1220

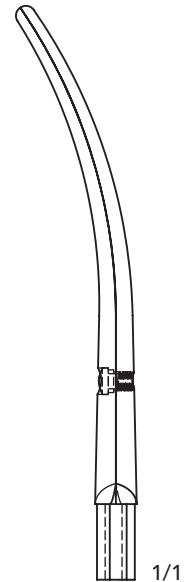

8" (200 mm)

SZ 1123



9" (225 mm)

SZ 1223

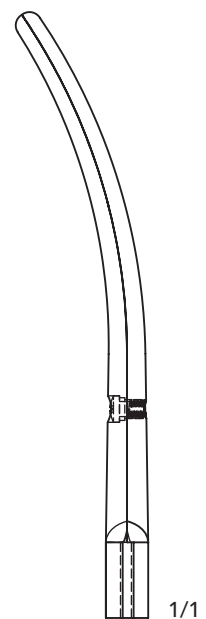

9" (225 mm)



Metzenbaum Scissors

[Go to Index](#)



SZ 1228

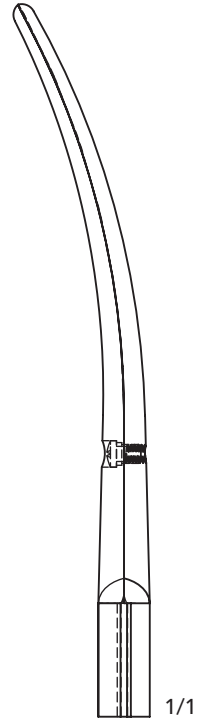

11" (270mm)

Nelson Metzenbaum Scissor

GENERAL INSTRUMENTS

Scissors

SY 2115

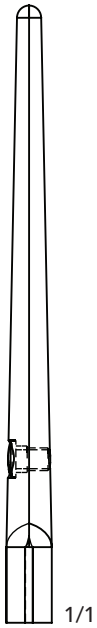

1/1

6" (155 mm)

SY 2215

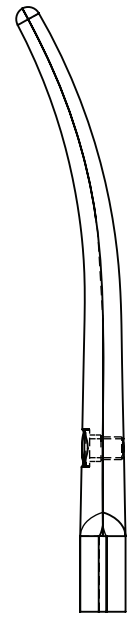

1/1

6" (155 mm)



Lexer Mayo Scissors 6"

SY 2117

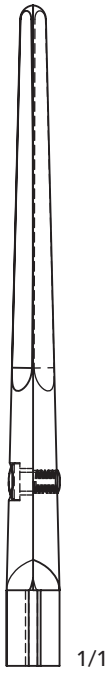

1/1
7" (175 mm)

SY 2217

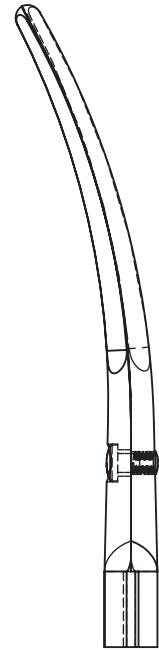

1/1
7" (175 mm)



Mayo Scissors 7"

GENERAL INSTRUMENTS

Scissors

SY 2120

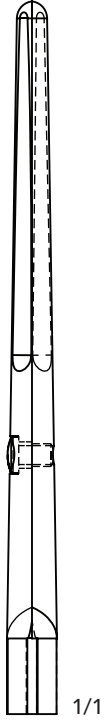

8" (200 mm)

SY 2220

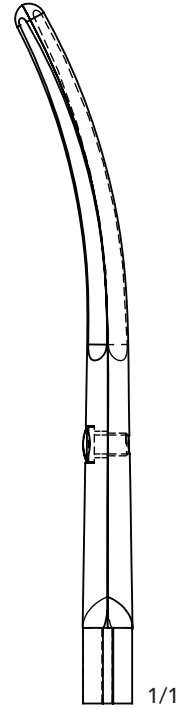

8" (200 mm)



Mayo Scissors 8"

[Go to Index](#)

GENERAL INSTRUMENTS

Needle Holders

NM 2015



6" (150 mm)

NM 2020



8" (200 mm)

NM 2025



10" (255 mm)

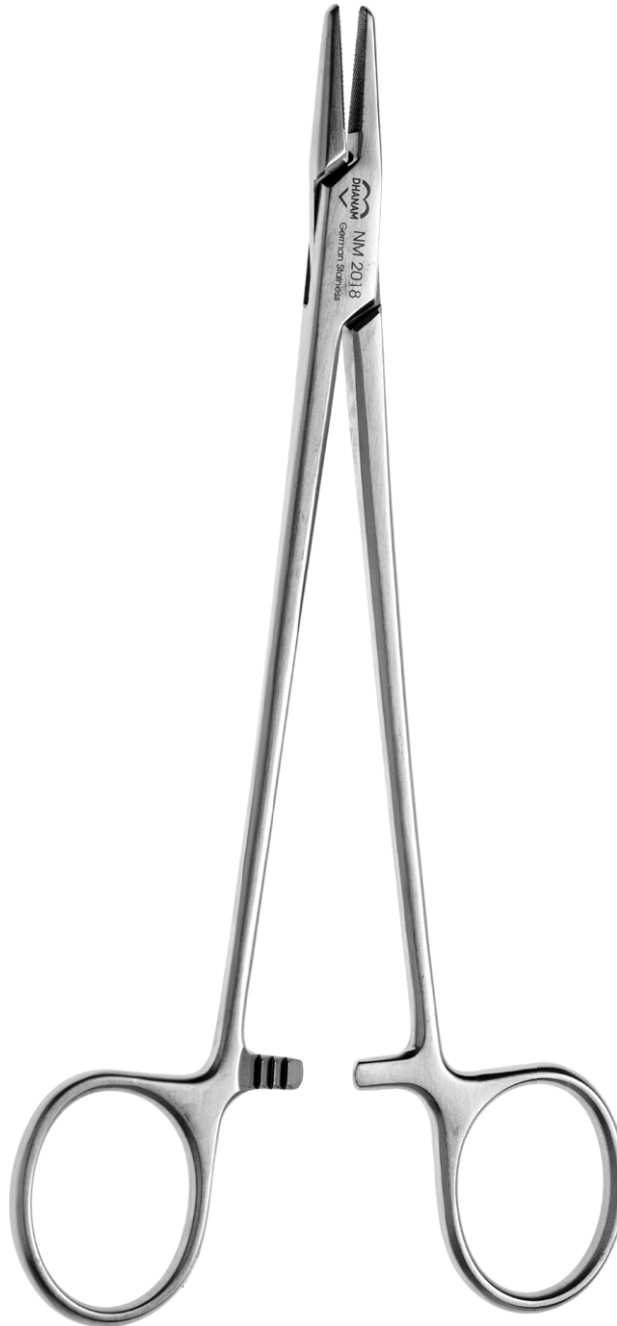

NM 2018



7" (175 mm)

NM 2023



9" (225 mm)

Mayo Hegar Needle Holders with TC Tip (1/O, 2/O & 3/O)

[Go to Index](#)

GENERAL INSTRUMENTS

Needle Holders

ND 3015



6" (150 mm)

ND 3020



8" (200 mm)

ND 3025



10" (255 mm)

ND 3018

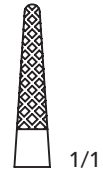

7" (175 mm)

ND 3023



9" (225 mm)

ND 3028

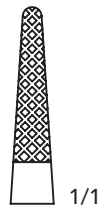

11" (280 mm)

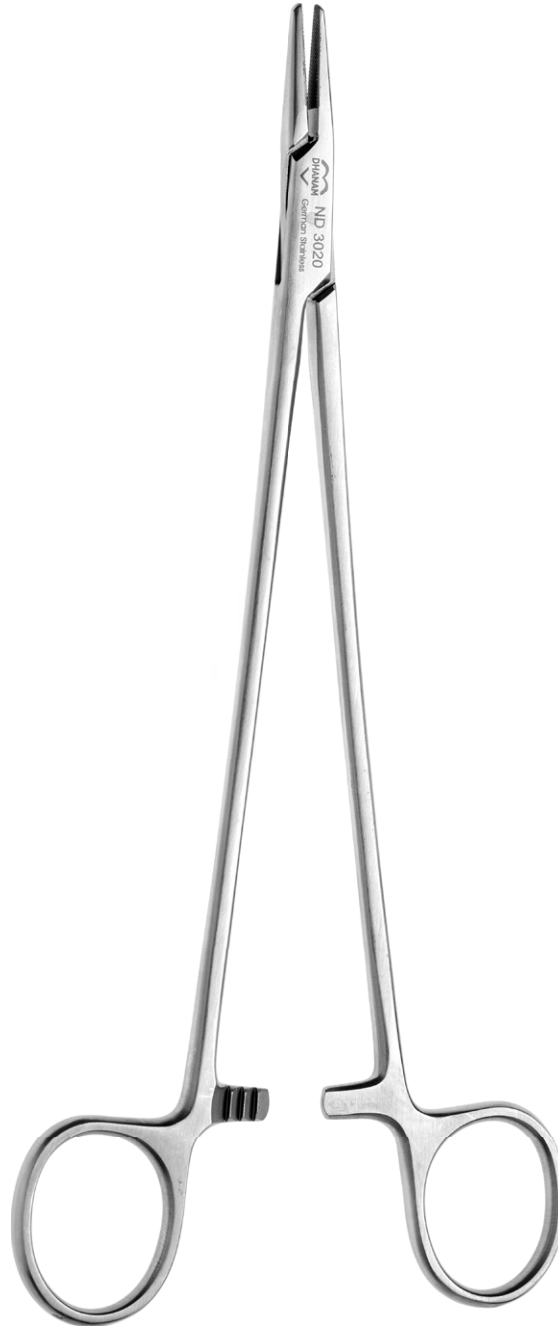

Debakey Needle Holders with TC tip (4/O & 5/O)

[Go to Index](#)

GENERAL INSTRUMENTS

Needle Holders

ND 2015

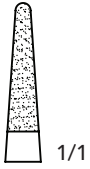

1/1
6" (150 mm)

ND 2018

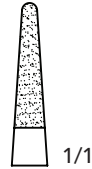

1/1
7" (175 mm)

ND 2020



1/1
8" (200 mm)

ND 2023

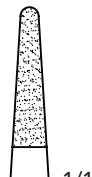

1/1
9" (225 mm)

ND 2025



1/1
10" (255 mm)

ND 2028

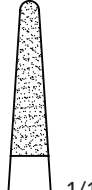

1/1
11" (280 mm)



Debakey Needle Holders Diamond Dusted (DD) (4/O & 5/O)

[Go to Index](#)

GENERAL INSTRUMENTS

Needle Holders

NR 5018



7" (175 mm)

NR 5020

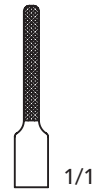

8" (200 mm)

NR 5023



9" (225 mm)



Ryder Needle Holders with TC tip (5/O & 6/O)

[Go to Index](#)

GENERAL INSTRUMENTS

Sternal Needle / Wire Twister

NW 7015

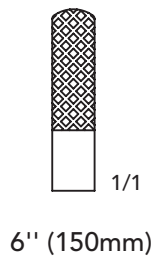

NW 7020

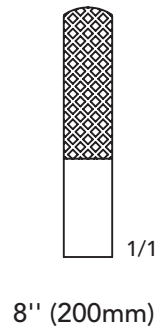

Sternal Needle / Wire Twister with TC Tip

[Go to Index](#)

GENERAL INSTRUMENTS

Wire Holder



WH 8015



6" (150 mm)

Wire Holder *WITHOUT TC Tip

** - This model is without TC tip, Only usable for Holding Purpose,
Not recommended to Heavy Usage and Wire Twisting.*

[Go to Index](#)

FP 1115

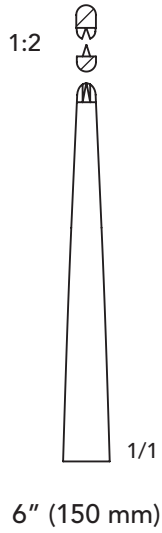

FP 1118

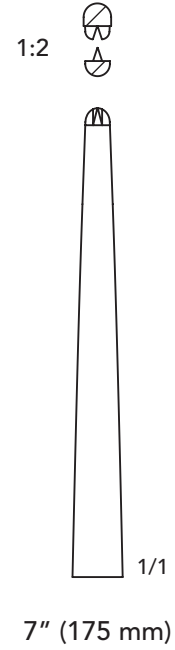

FP 1318

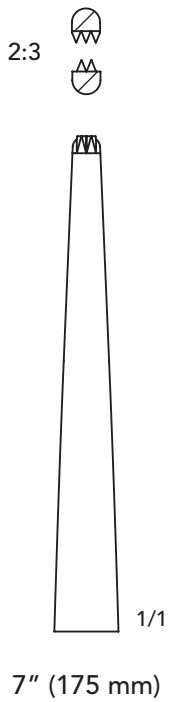

Toothed Dissecting Forceps

[Go to Index](#)

GENERAL INSTRUMENTS

Dissecting Forceps



FP 1215



6" (150 mm)

FP 1218

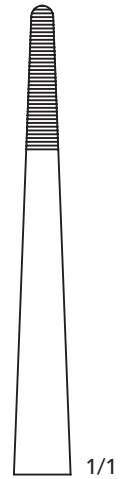

7" (175 mm)



Non-Toothed Dissecting Forceps

[Go to Index](#)

FA 2113

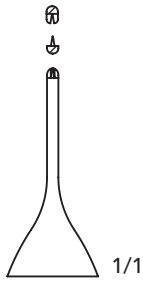

5" (125 mm)

Toothed



FA 2213

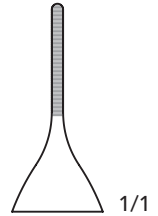

5" (125 mm)

Non - Toothed

Adson Forceps

[Go to Index](#)

GENERAL INSTRUMENTS

Dissecting Forceps

FT 4020

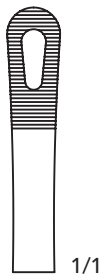

1/1

8" (200 mm)

FT 4025



1/1

10" (250 mm)



Tuttle Forceps

[Go to Index](#)

FR 3020



1/1
8" (200 mm)

FR 3025

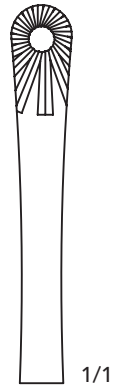

1/1
10" (250 mm)



Russian Forceps

GENERAL INSTRUMENTS

Tube Holding Instruments



LR 5020



Tube Milker 8", 200 mm

LO 6015



Tube Organizer with Base Plate 8", 200 mm
(Stainless Steel)

[Go to Index](#)

GENERAL INSTRUMENTS

Tube Holding Instruments

LT 1015



6" (150mm)

LT 1020

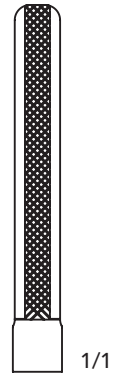

8" (200mm)



Tube Clamps

[Go to Index](#)

GENERAL INSTRUMENTS

Tube Holding Instruments

LT 1215

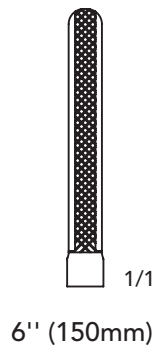

LT 1220

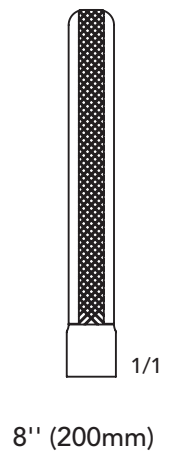

Tube Clamps With Guard

GENERAL INSTRUMENTS

Wire Cutters



Double Action Wire Cutters (TC Tip)

[Go to Index](#)

GENERAL INSTRUMENTS

Dilators

DH 3015



Hegar Dilators 9", 225 mm

[Go to Index](#)

DR 5112



1/1

Trachal Dilator 5", 125 mm

HW 1015



3/4

Scale 6", 150 mm

HW 1030



1/2

Scale 12", 300 mm

HW 2015



1/1

Spoon 6", 150 mm

[Go to Index](#)

HW 4010



3/4

Small 8", 200 mm

HW 4020



3/4

Big 10", 250 mm

Kidney Trays

[Go to Index](#)

GENERAL INSTRUMENTS

Hollow Wares



HW 3010



1/1

Small 3", 75 mm

HW 3020



1/1

Medium 4", 100 mm

HW 3030



1/1

Big 5", 125 mm

Bowels

[Go to Index](#)

RETRACTORS

CHAPTER - 06

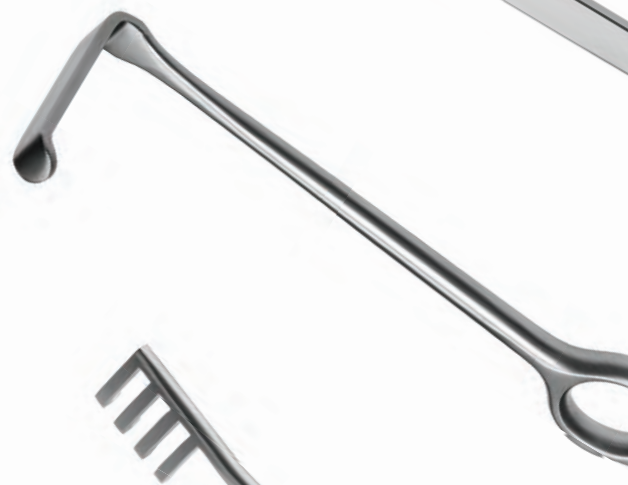
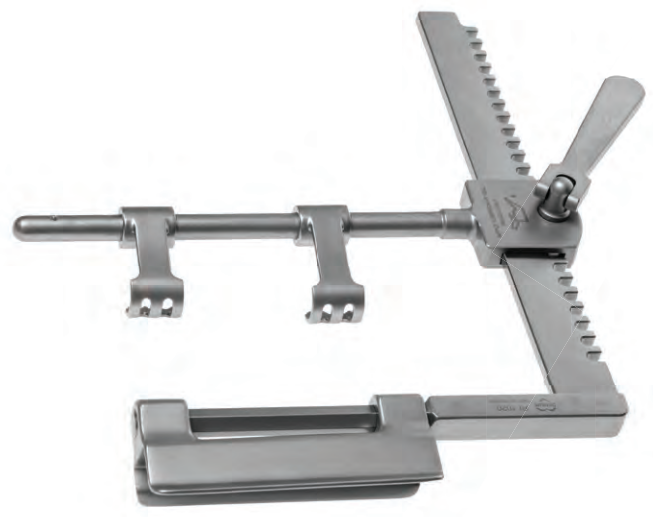

[Go to Index](#)

RETRACTORS

Rib / Sternal Spreaders

RF 2001T

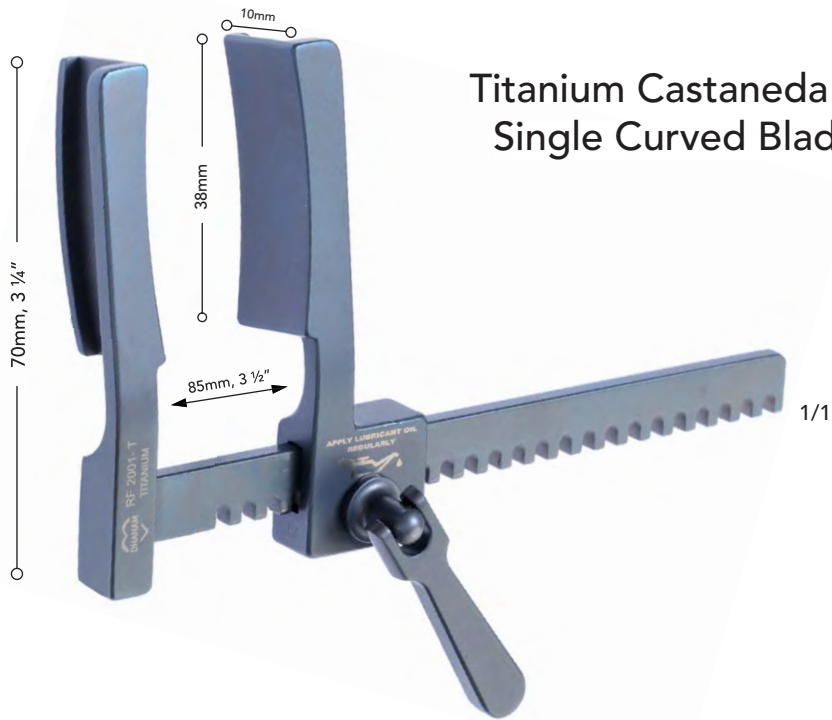

Titanium Castaneda Retractor with
Single Curved Blade Extra Small

RF 2002T

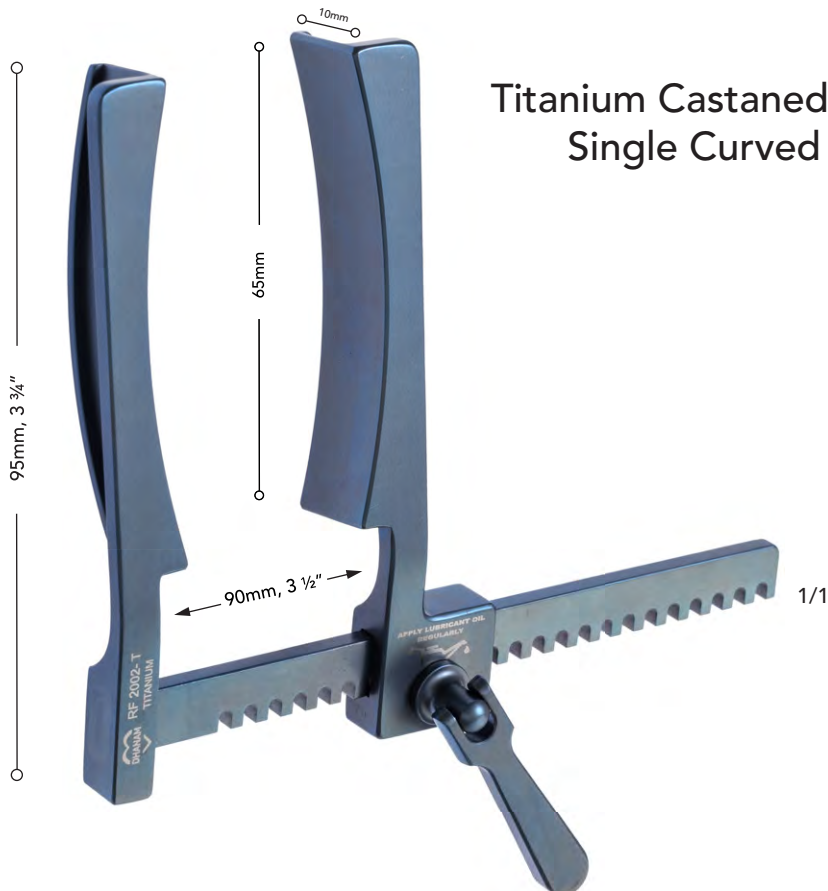

Titanium Castaneda Retractor with
Single Curved Blade Small

[Go to Index](#)

RETRACTORS

Rib / Sternal Spreaders

RF 2003

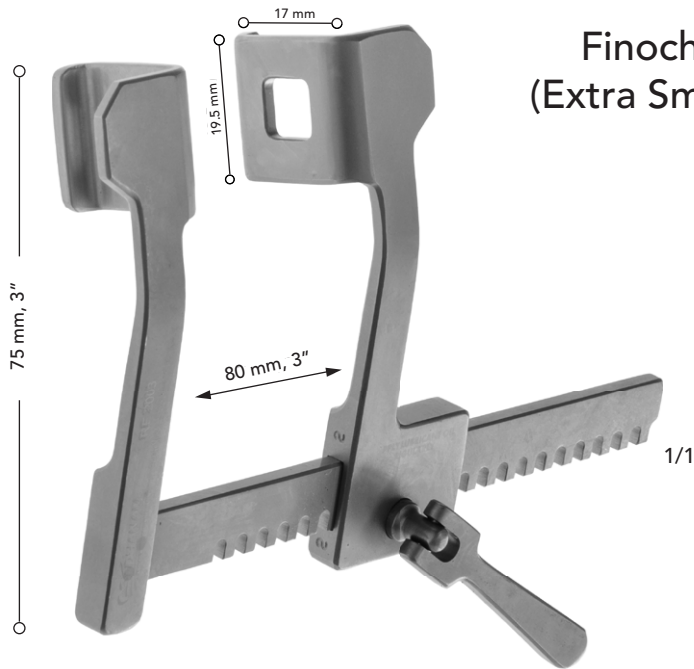

Finochietto Rib Retractor
(Extra Small) With Single Blade

RF 2110

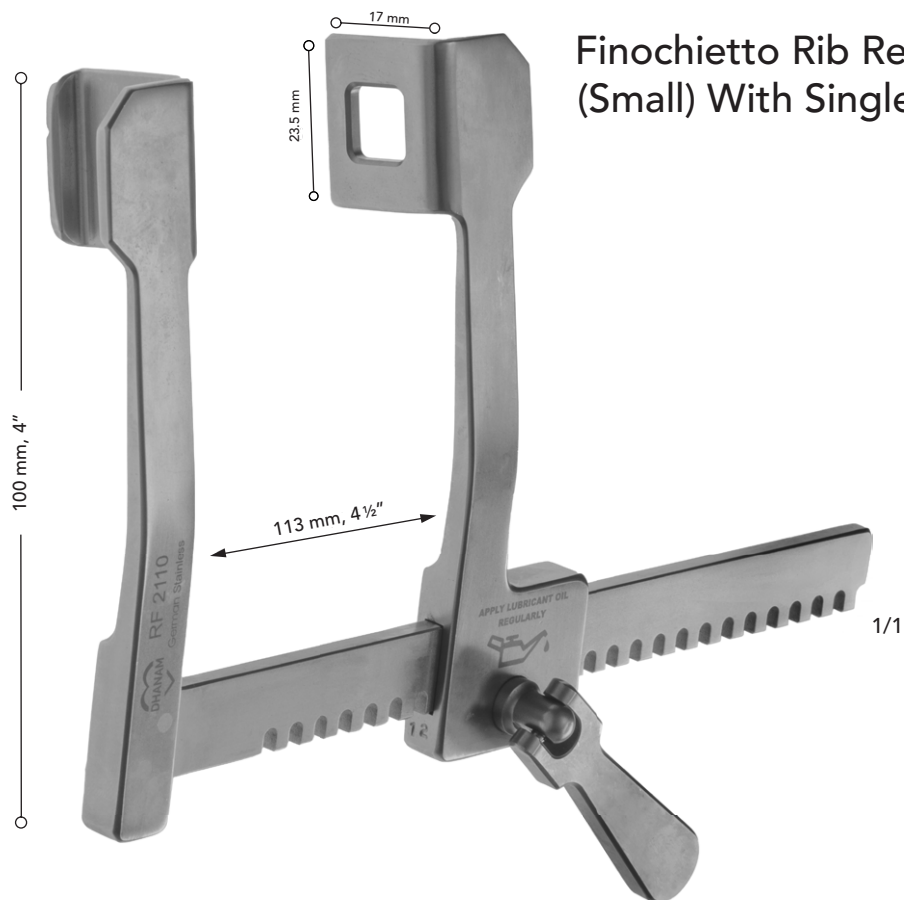

Finochietto Rib Retractor
(Small) With Single Blade

[Go to Index](#)

RETRACTORS

Rib / Sternal Spreaders

RM 4008



Morse Sternal Spreader
(Extra Small) With Double Blades

RM 4110

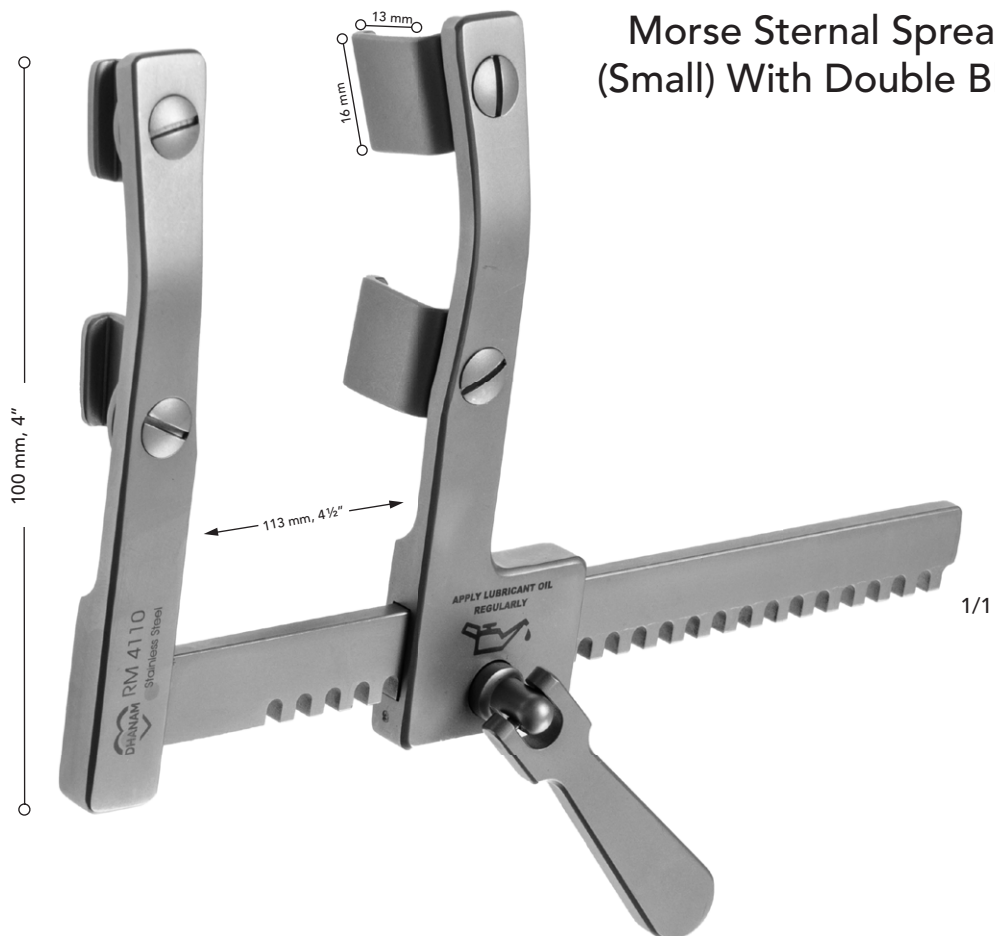

Morse Sternal Spreader
(Small) With Double Blades

[Go to Index](#)

RETRACTORS

Rib / Sternal Spreaders

RF 2215

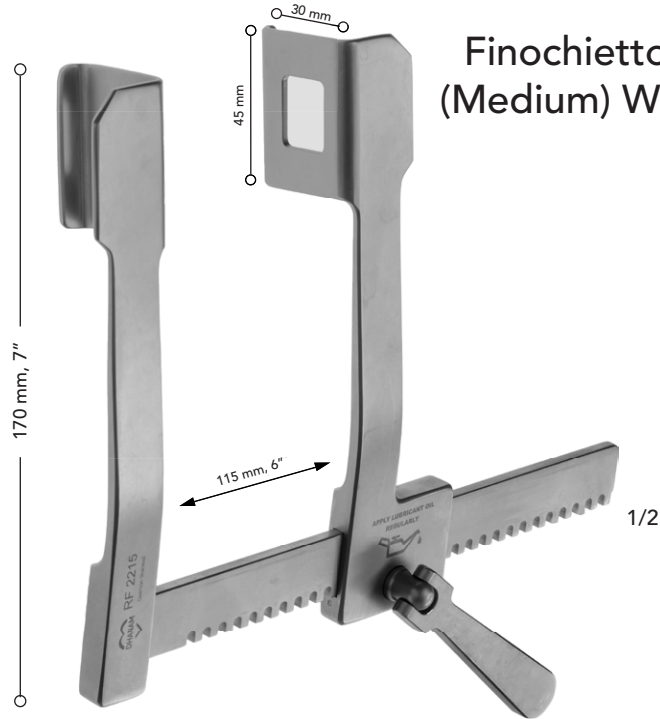

Finochietto Rib Retractor
(Medium) With Single Blade

RF 2320

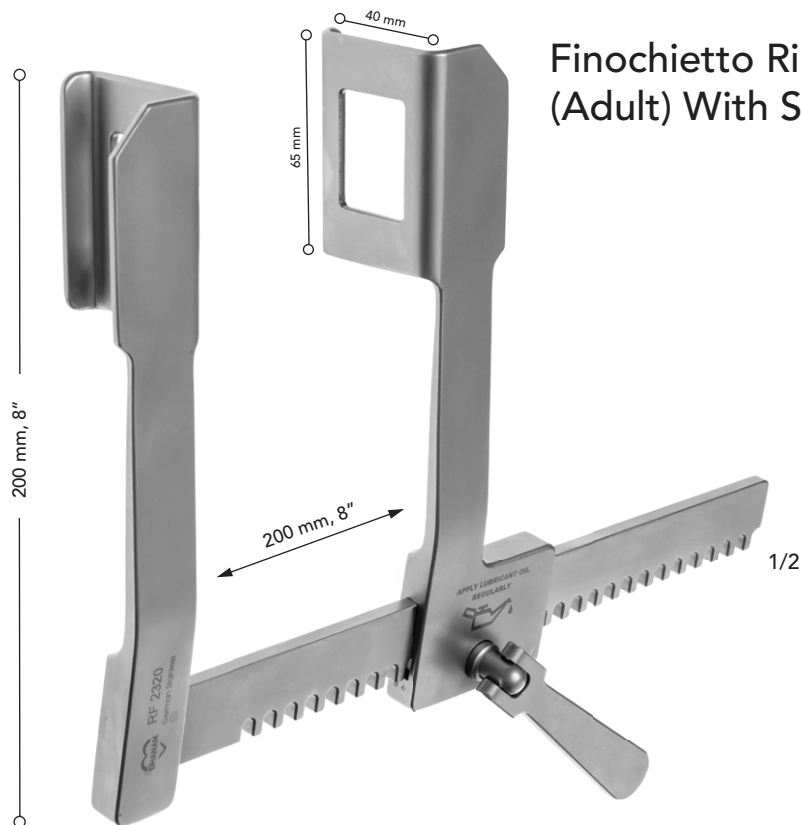

Finochietto Rib Retractor
(Adult) With Single Blade

[Go to Index](#)

RETRACTORS

Rib / Sternal Spreaders

RF 2425



Small Blade - 45x64mm

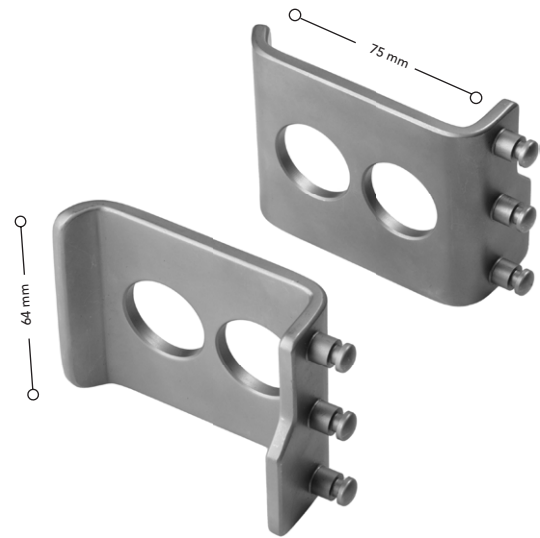

Big Blade - 75x64mm

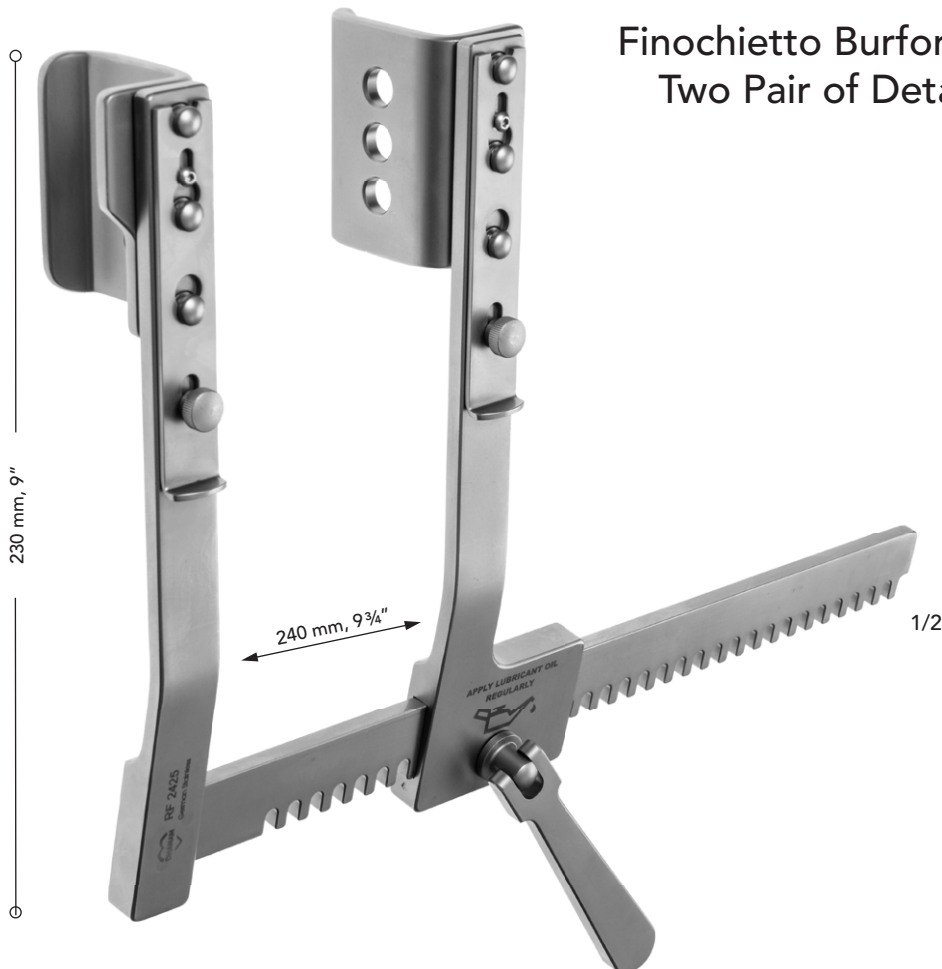

Finochietto Burford Retractor With Two Pair of Detachable Blades

[Go to Index](#)

RETRACTORS

Rib / Sternal Spreaders

RM 4112

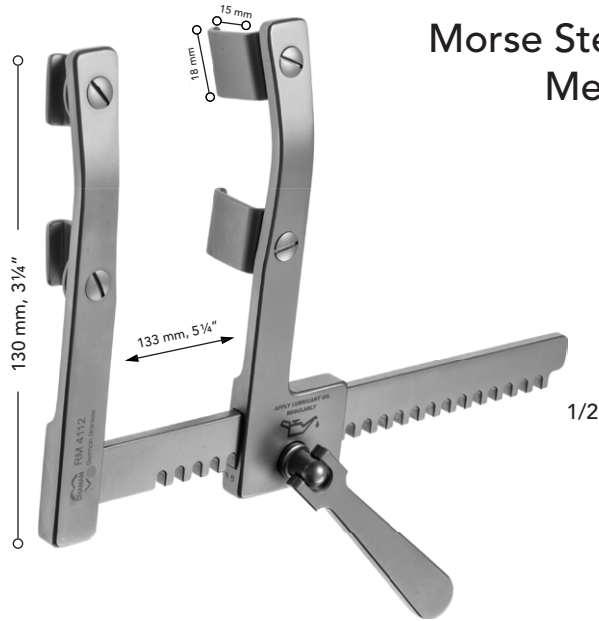

Morse Sternal Spreader Inbetween Medium & Small (IMS)

RM 4215

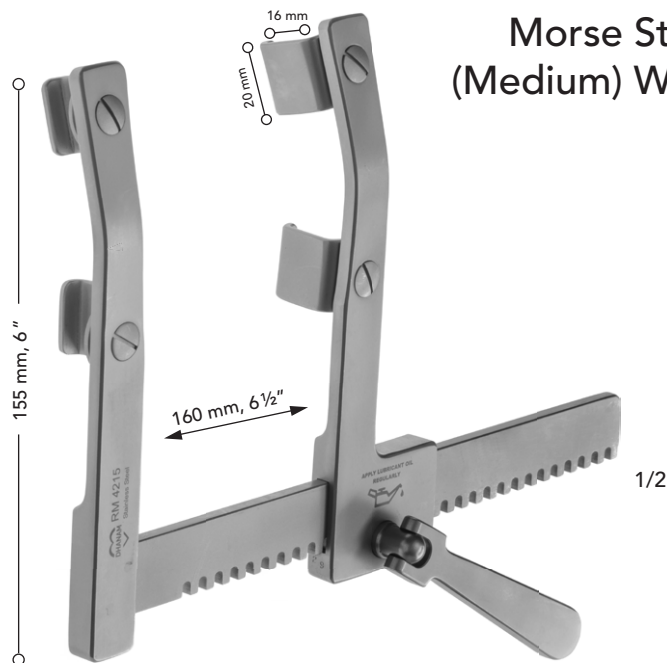

Morse Sternal Spreader (Medium) With Double Blades

RETRACTORS

Rib / Sternal Spreaders

RM 4320

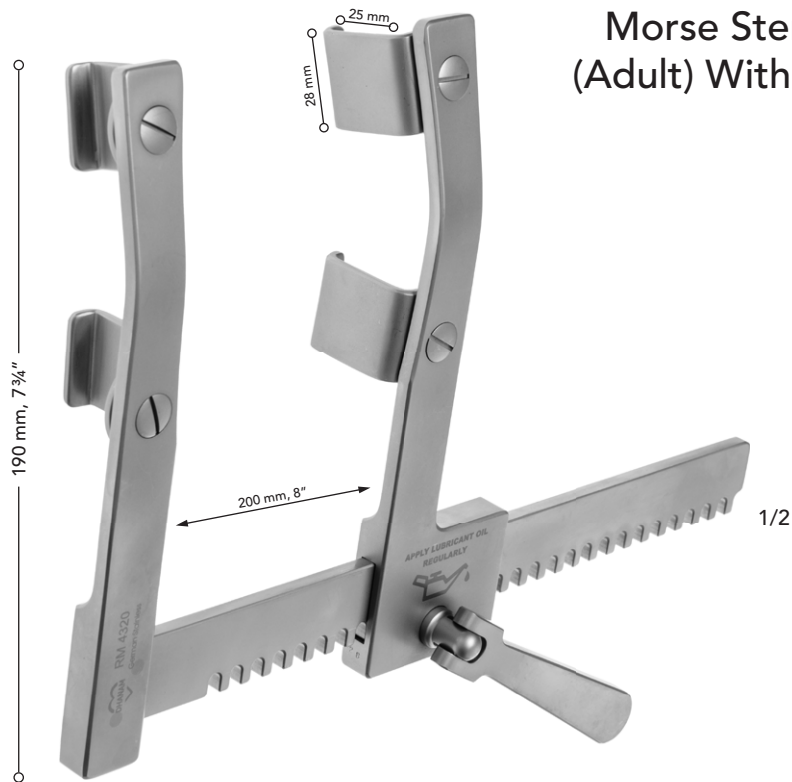

Morse Sternal Spreader
(Adult) With Double Blades

RM 4420

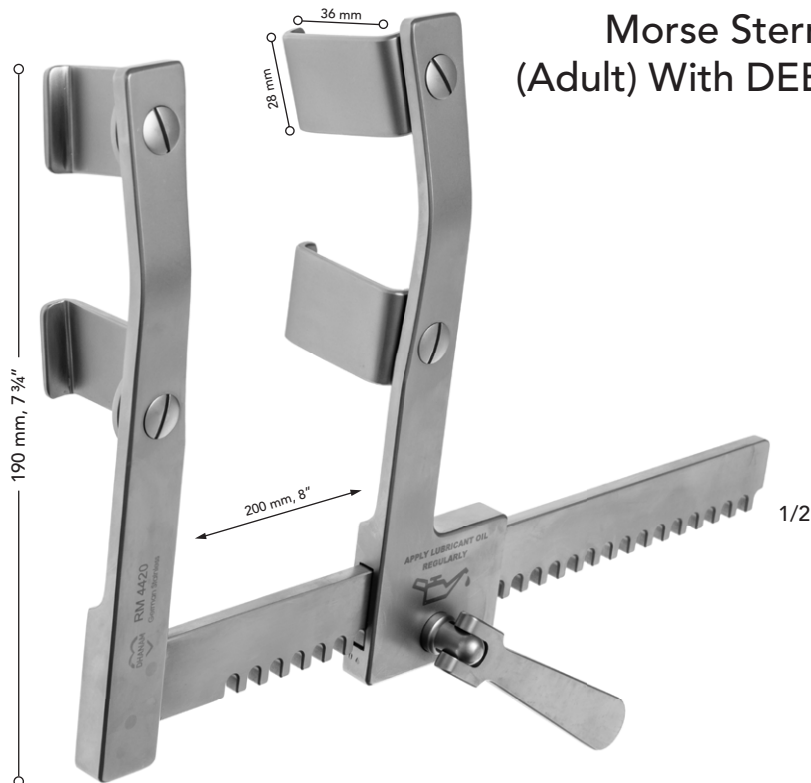

Morse Sternal Spreader
(Adult) With DEEP Double Blades

[Go to Index](#)

RETRACTORS

Rib / Sternal Spreaders

RM 4320-NH

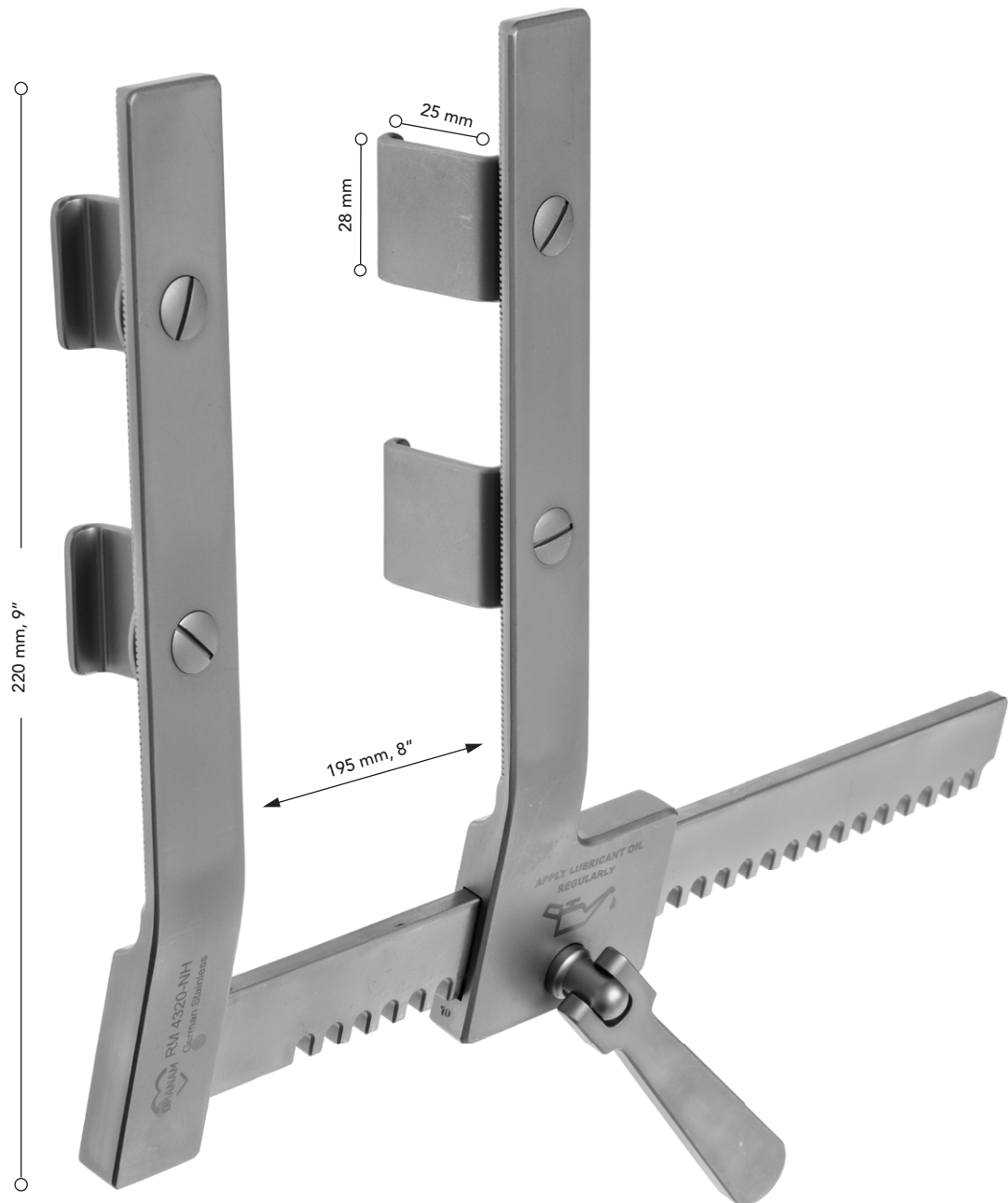

Morse Sternal Spreader (Adult)
with tissue stabilizer compatibility

[Go to Index](#)

RETRACTORS

Rib / Sternal Spreaders

RI 1020

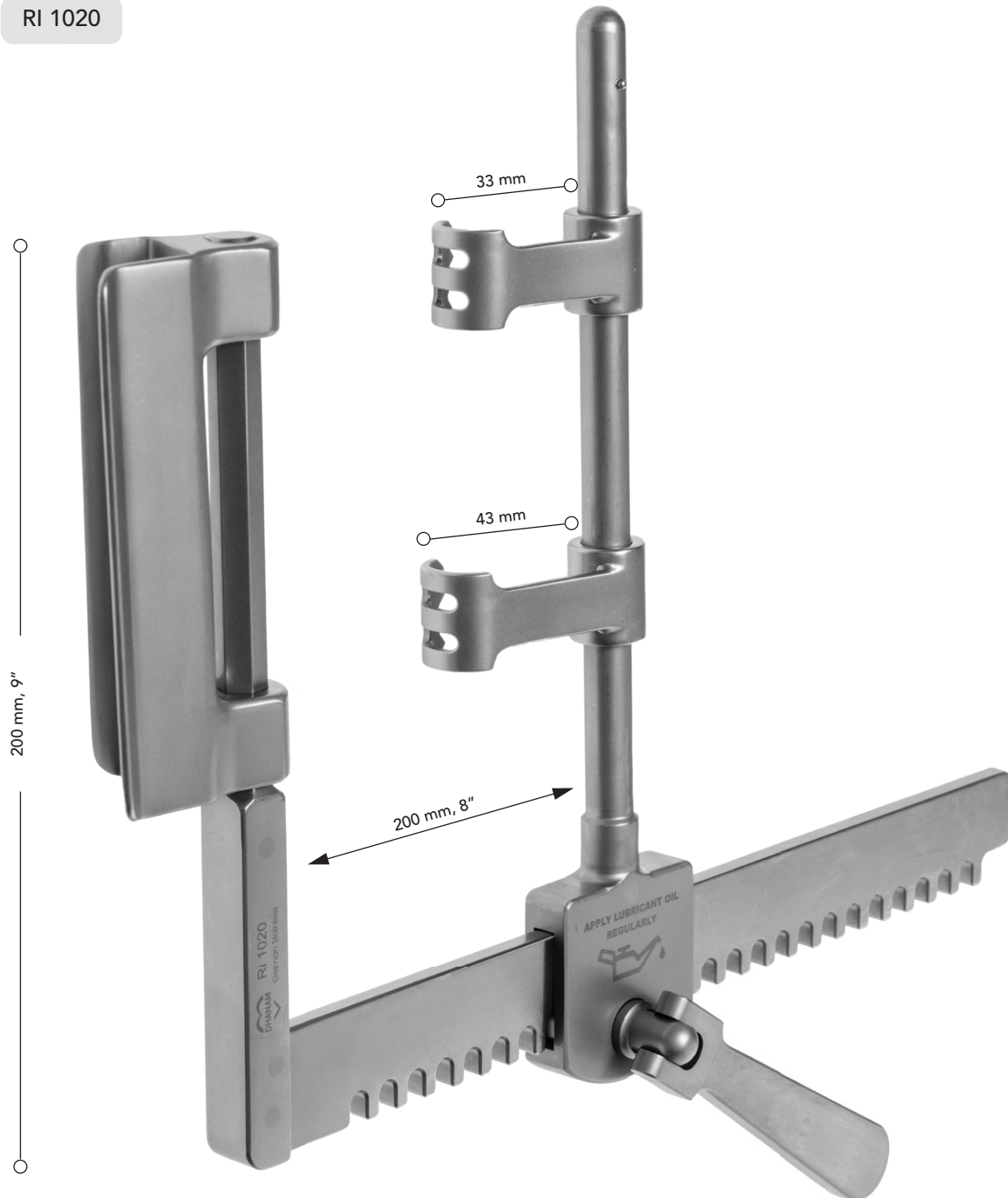

IMA Retractor

[Go to Index](#)

RI 0110



IMA Retractor Blade
(To convert standard double blade Retractor to IMA Retractor)

[Go to Index](#)

RETRACTORS

Rib / Sternal Spreaders

RB 1018



Bailey Rib Approximator (Small)

RB 1020



Bailey Rib Approximator (Big)

RETRACTORS

Rib / Sternal Spreaders

RP 1020



Designed by
Dr. P.V. Rao FRCS, FRCS

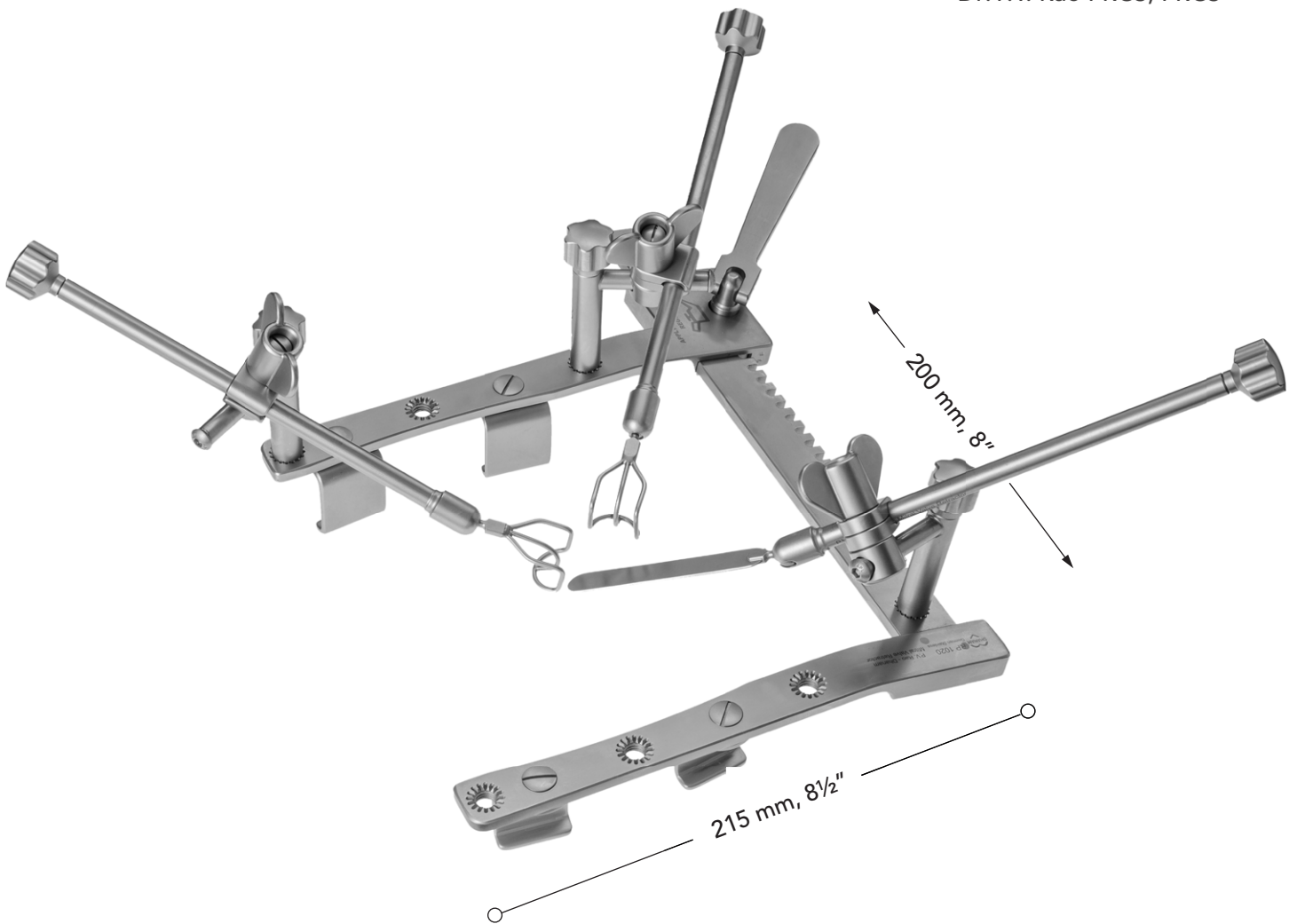

PV Rao-Dhanam Mitral Valve Exposure System

[Go to Index](#)

RETRACTORS

Rib / Sternal Spreaders

RC 1020

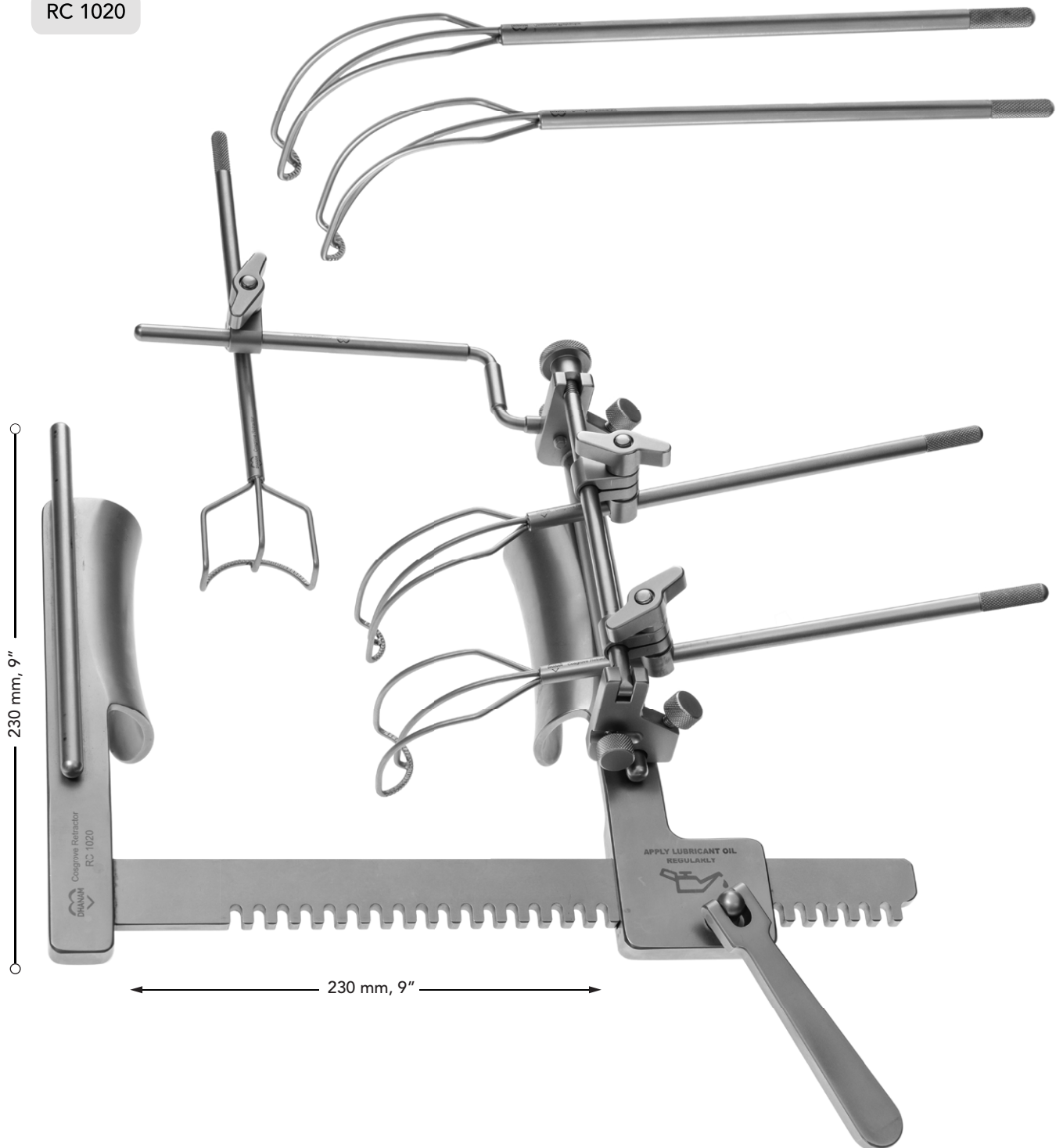

Cosgrove Mitral Valve Exposure System with
5 Cooley Retractors

[Go to Index](#)

RETRACTORS

Self Retaining Retractors

RH 1113



RH 2113

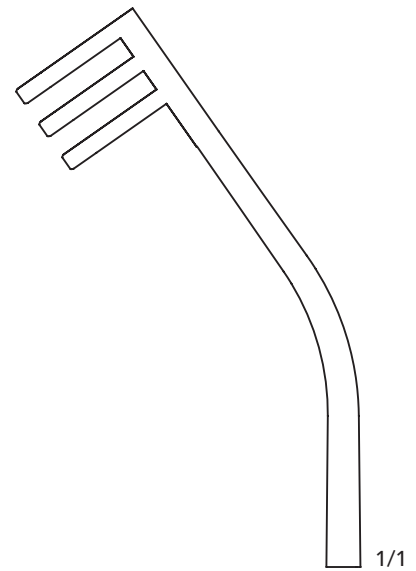
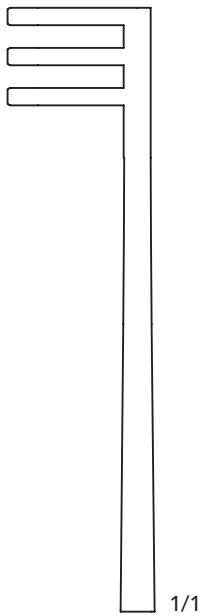

Henly Popliteal Self Retaining Retractor (Small) 5 1/2"

[Go to Index](#)

RETRACTORS

Self Retaining Retractors

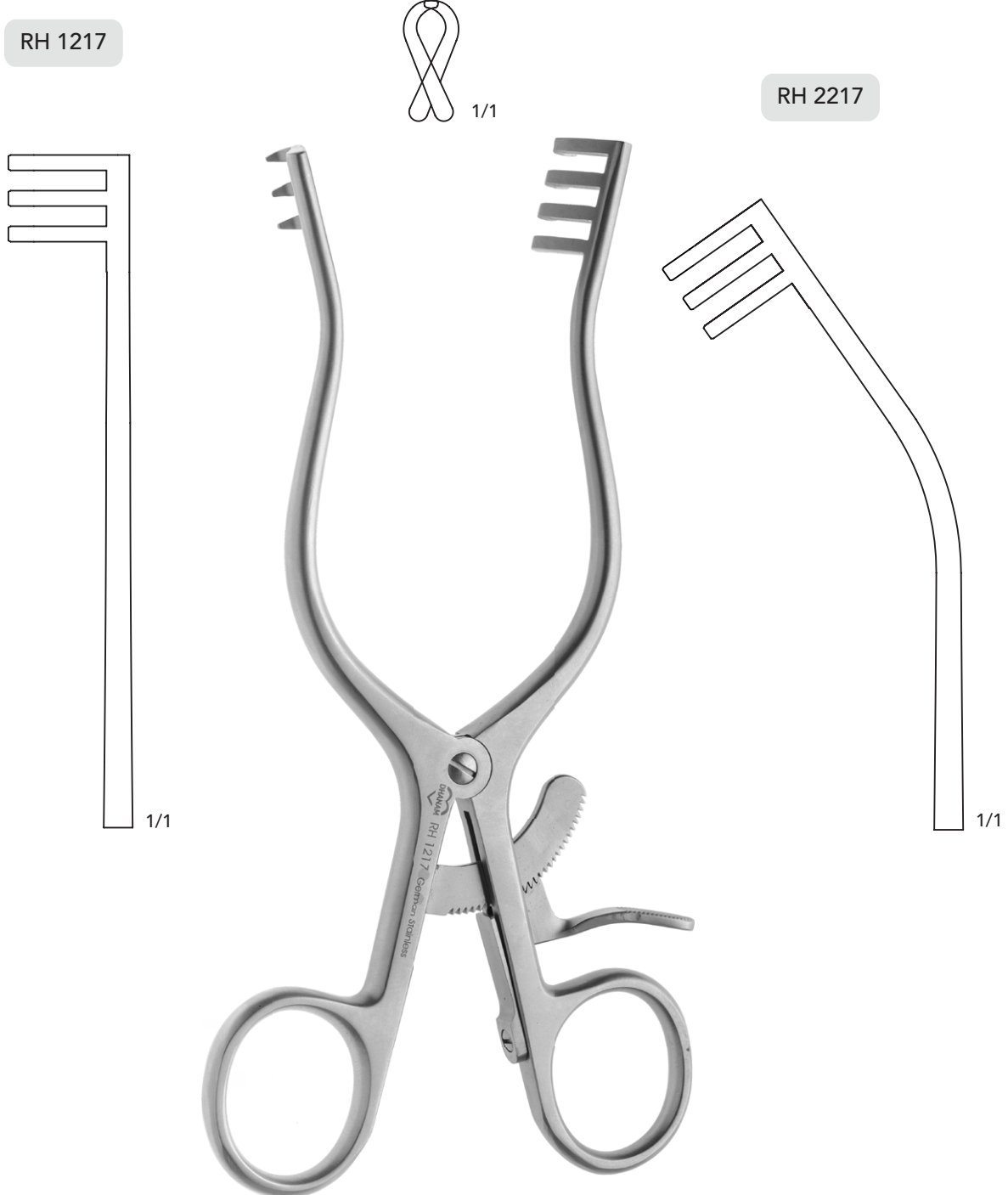

Henly Popliteal Self Retaining Retractor (Medium) 6 1/2"

[Go to Index](#)

RETRACTORS

Self Retaining Retractors

RH 1320



RH 2320

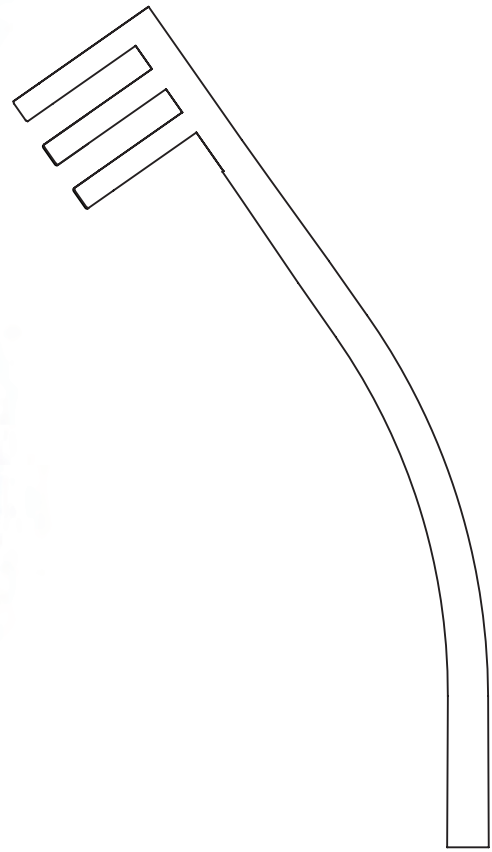
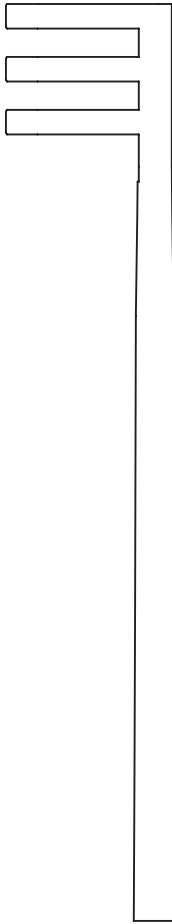

Henly Popliteal Self Retaining Retractor (Big) 8"

[Go to Index](#)

RETRACTORS

Aortic Valve Retractors

RC 4127



3/4

Aortic Valve Retractors 10"

RC 4227



1/1

Small - 13 x 22 mm



1/1

Medium - 17 x 24 mm

RC 4327



1/1

Big - 30 x 28 mm

[Go to Index](#)

RETRACTORS

Cooly Mitral Valve Retractors



3/4

RC 2128



1/1

Small
25 mm Width

RC 2228



1/1

Medium
35 mm Width

RC 2328



1/1

Big
45 mm Width

Cooly Mitral Valve Retractors, Right 9 1/2"

[Go to Index](#)

RETRACTORS

Cooly Mitral Valve Retractor



RC 3328

RC 3228

RC 3128



Small
25 mm Width



Medium
35 mm Width



Big
45 mm Width

Cooly Mitral Valve Retractors, Left 9 1/2"

[Go to Index](#)

RETRACTORS

Kocher - Langenbeck Retractor



RL 4121

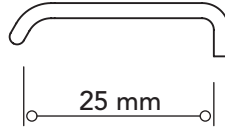

6 mm

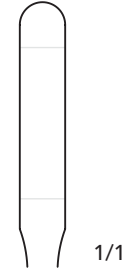

RL 4221

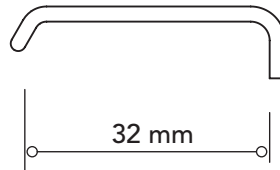

11 mm

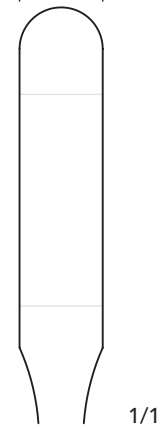

RL 4321

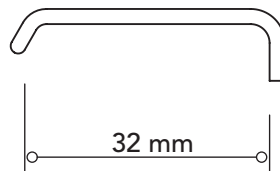

15 mm



Kocher- Langenbeck Retractors 8 1/2"

RETRACTORS

Baby – Langenbeck Retractor



RL 4118

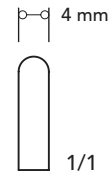
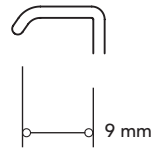

RL 4218

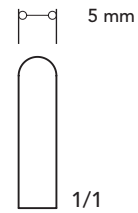
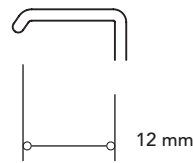

RL 4318

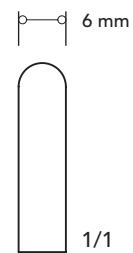
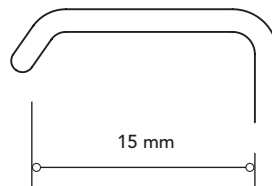

Baby- Langenbeck Retractors 7"

[Go to Index](#)

RETRACTORS

VSD Retractors



RV 5120



RV 5220



RV 5320



RV 5420



RV 5520



VSD Retractors 8"

RETRACTORS

Harrington Retractors

RA 6130



45 mm

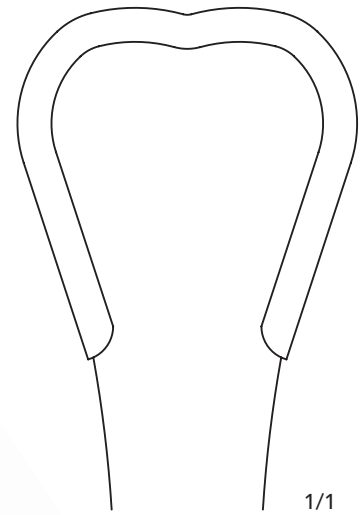

Medium

RA 6230

65 mm

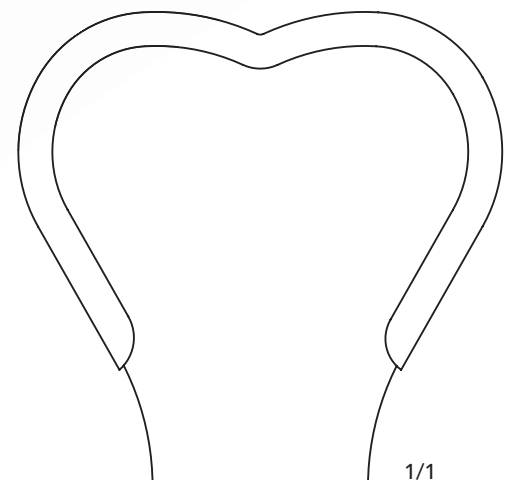

Big

Harrington Retractors 12"

[Go to Index](#)

RETRACTORS

Davers Retractors

RE 3028



Small (26 mm)

RE 4034



Medium (38 mm)

RE 5034



Big (50 mm)

Davers Retractors 12"

[Go to Index](#)

RETRACTORS

Davidson Retractors



RD 7120

RD 7222



Small



Big

Davidson Scapula Retractors 8"

[Go to Index](#)

RETRACTORS

Allison Lung Retractors



Allison Lung Retractors

[Go to Index](#)

RETRACTORS

Mories Retractors

RO 1100

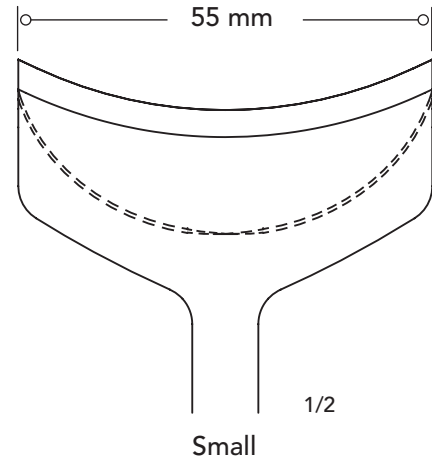
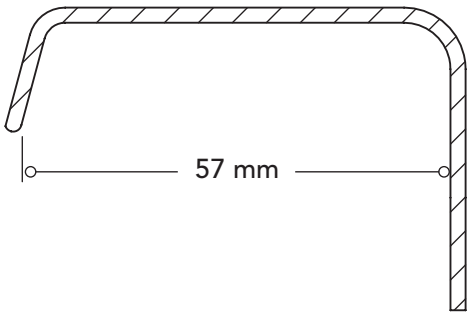

RO 1200

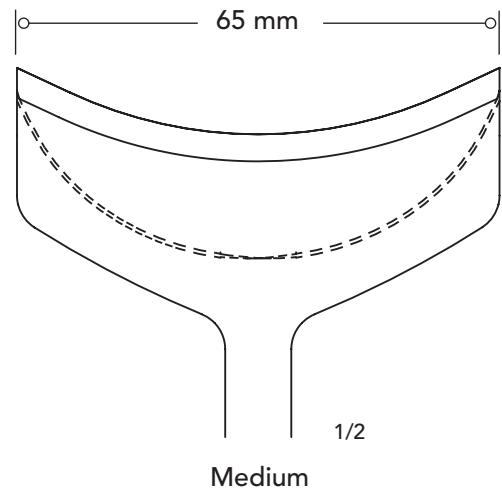

RO 1300

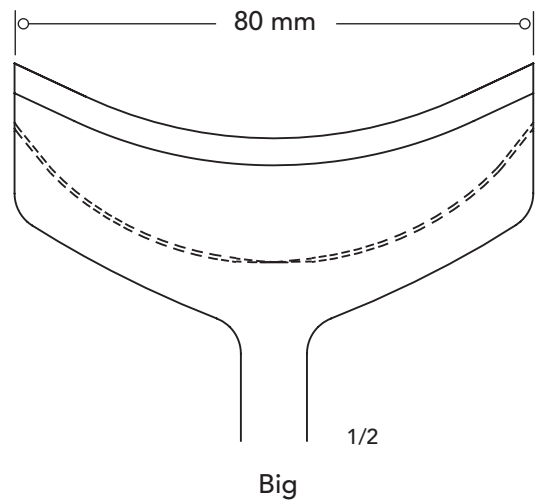

Mories Retractors 9 1/2"

[Go to Index](#)

RETRACTORS

Rack Retractors

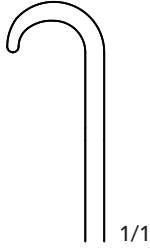

RR 9120



RR 9220

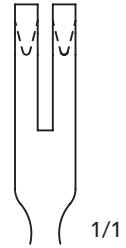

RR 9320

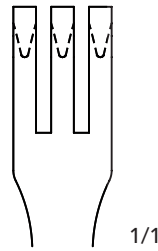

RR 9420

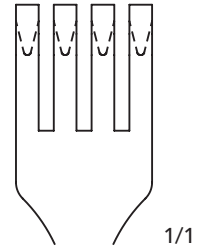

RR 9520

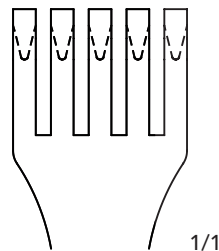

RR 9620

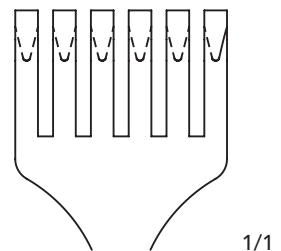

Rack Retractors 8 3/4"

RETRACTORS

Baby Rack Retractors

RR 9316



Baby Rack Retractor
Three Hooks 7"

RS 0318



Muller-Senn/Cats Paw
Retractor 7"

[Go to Index](#)

RETRACTORS

Zereny Retractor

RZ 0220

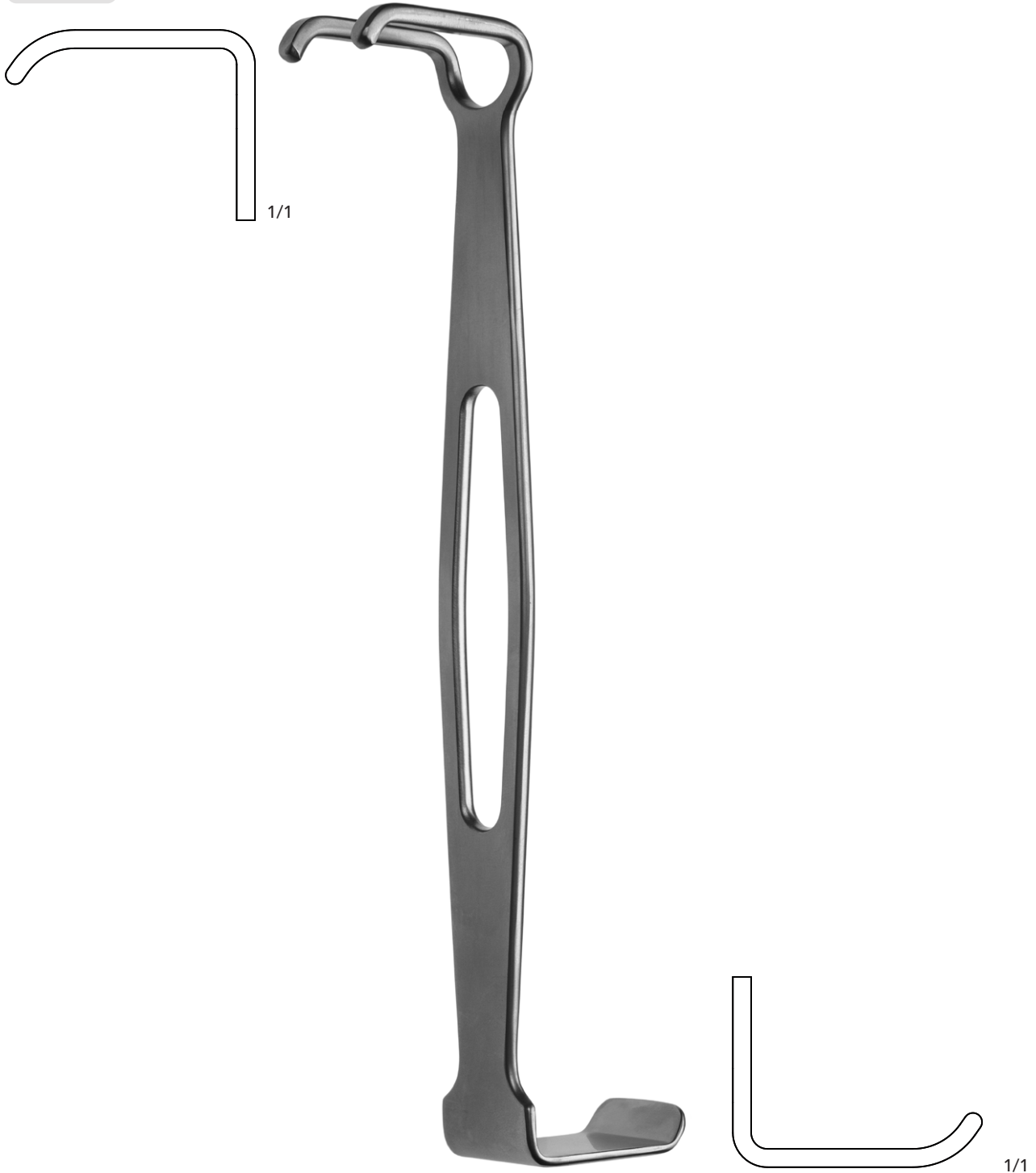

Zereny Retractor 8"

[Go to Index](#)

RETRACTORS

Epicardial Fat Retractors

RE 0103



Single Prong 1"

RE 0104



Single Prong 1.5"

RE 0106

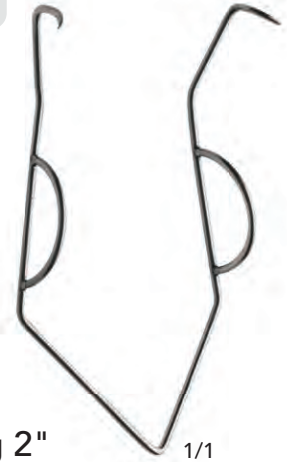

Single Prong 2"

RE 0203



Two Prongs 1"

RE 0204



Two Prongs 1.5"

RE 0206

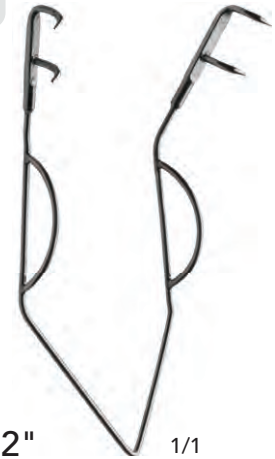

Two Prongs 2"

RE 0303



Three Prongs 1"

RE 0304



Three Prongs 1.5"

RE 0306





Three Prongs 2"

Epicardial Fat Retractors

[Go to Index](#)

RETRACTORS

Malleable Retractors

RI 0005		5 mm
RI 0010		10 mm
RI 0015		15 mm
RI 0020		20 mm
RI 0025		25 mm
RI 0030		30 mm
RI 0035		35 mm
RI 0040		40 mm
RI 0045		45 mm
RI 0050		50 mm

Malleable / Ribbon Retractors

[Go to Index](#)

RETRACTORS

Hooks

HN 1120



Nerve Hook 8"

HT 4120



Trachal Hook 7"

HS 1318



Skin Hook 7"

[Go to Index](#)



HM 2125

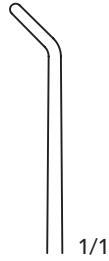

45 degree

HM 2225

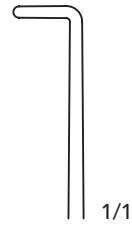

90 degree

HM 2325

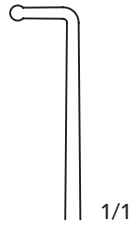

90 degree Ball Tip

HM 2425



Question Mark Tip

Mitral Hooks 11"

RETRACTORS Hooks

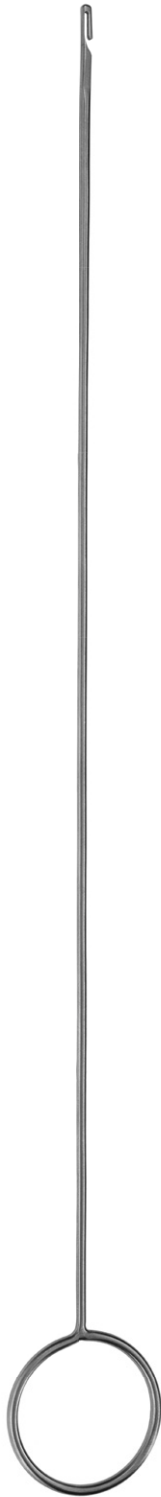

HG 3125

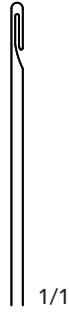

1.5 mm Small

HG 3225



2.0 mm Medium

HG 3325



2.6 mm Big

Snigger Rods 10"

[Go to Index](#)

SUCTION INSTRUMENTS

CHAPTER - 07



[Go to Index](#)

SUCTION INSTRUMENTS

Cardiotomy Suction Tubes

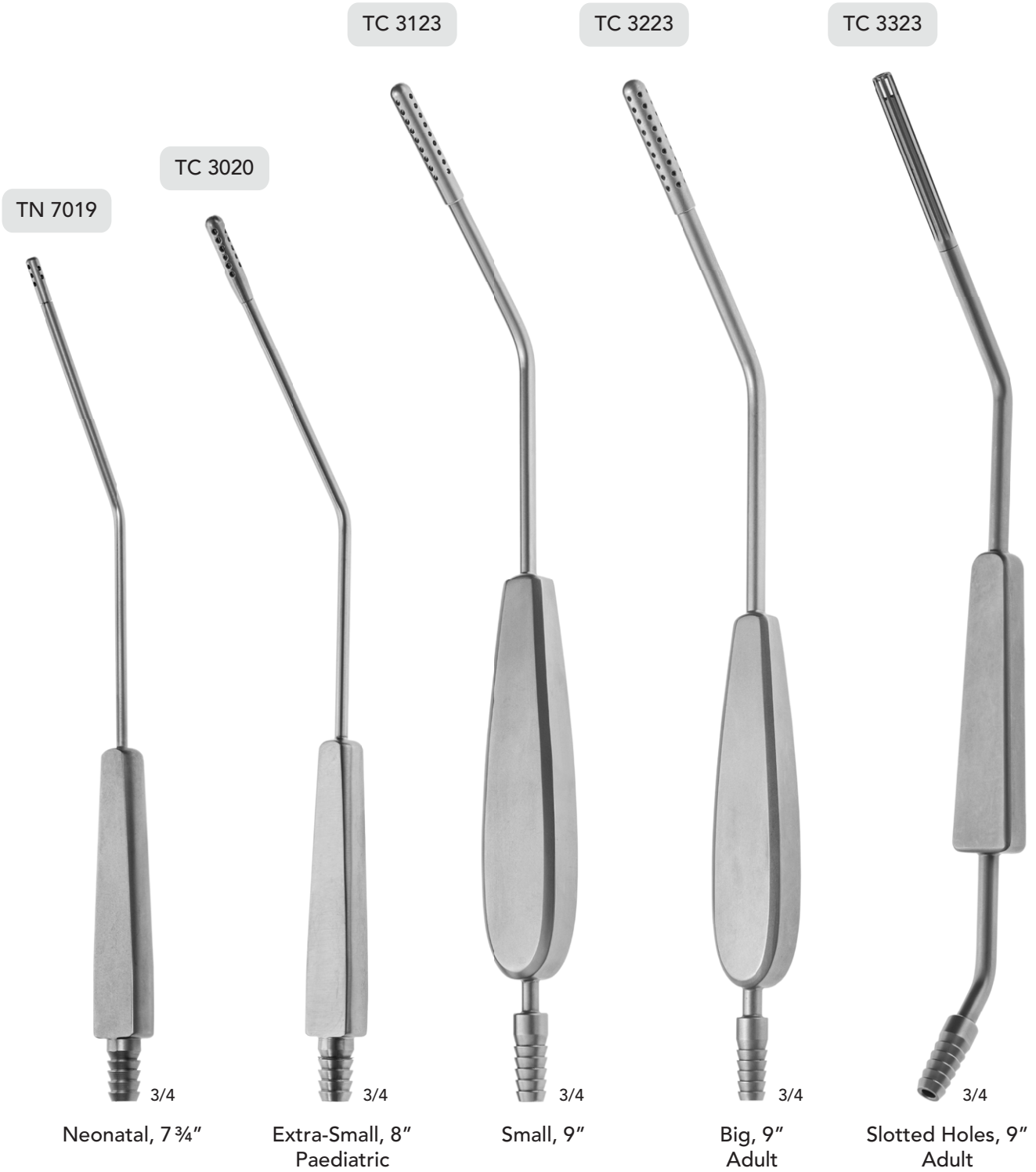

Cardiotomy Suction Tubes

[Go to Index](#)

SUCTION INSTRUMENTS

Rough Suction Tubes



TY 2119

TM 1025

TY 2028

3/4
Baby Yankauer Rough Suction (Neonatal), 7"

3/4
Morse- Andrews Suction Tube (Small), 10"

3/4
Yankauer Suction Tube, 11"

[Go to Index](#)

SUCTION INSTRUMENTS

Suction Tips



TS 6118



Fraizer Suction Tip # 1

TS 6218



Fraizer Suction Tip # 2

TS 6318



Fraizer Suction Tip # 3

TS 6418



Fraizer Suction Tip # 4

Fraizer Suction Tips 7", 180 mm

[Go to Index](#)

Bullet Suction Tips

TB 4102



1/1

Small, 35 mm

TB 4203



1/1

Medium, 40 mm

TB 4304



1/1

Big, 45 mm

Heparin / Irrigation Cannula

TH 5106



1/1

2 mm Angle Tip
60 mm Long

TH 5206



1/1

2 mm Oval Tip
60 mm Long

TH 5108



1/1

3 mm Angle Tip
75 mm Long

TH 5208



1/1

3 mm Oval Tip
75 mm Long

C-Needle

NG 1014



1/1

NG 2016



1/1

NG 3018



1/1

[Go to Index](#)

BONE INSTRUMENTS

CHAPTER - 08



[Go to Index](#)

BONE INSTRUMENTS

Bone Cutters

OB 1223



Bone Cutting Forceps
9", 230 mm

ON 2123



Bone Nibbler
9", 230 mm

[Go to Index](#)

BONE INSTRUMENTS

Bone Cutters

OS 4120

OH 3018



1/1

Bone Hole 6", 150 mm



1/1

Scoop 8", 200 mm

[Go to Index](#)

BONE INSTRUMENTS

Elevators

OD 5120

OD 5220

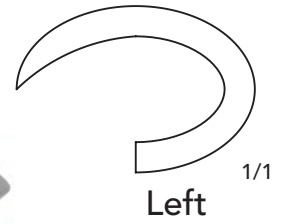
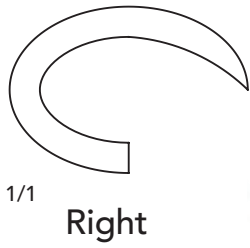

Doyen Raspatories 6", 150 mm

[Go to Index](#)

BONE INSTRUMENTS

Elevators

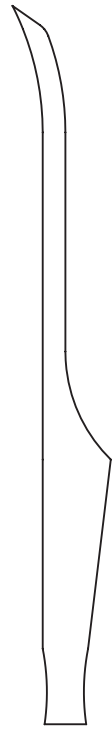

OL 0521

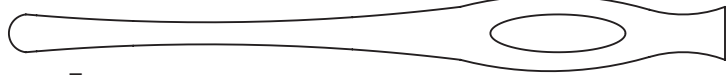

5 mm

1/1

OL 1021

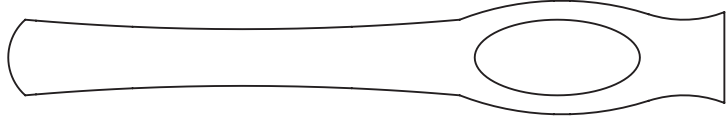

10 mm

1/1

OL 1521

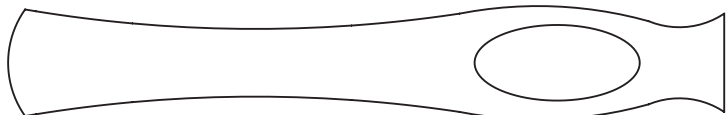

15 mm

1/1

OL 2021

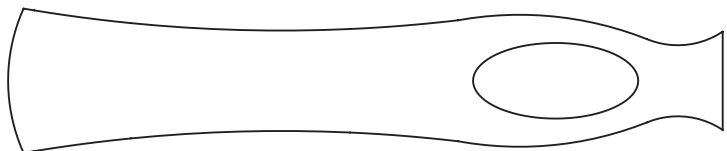

20 mm

1/1

OL 2521

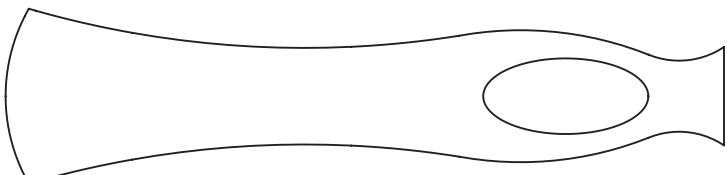

25 mm

1/1

Lambotte Bone Raspatories 9", 230 mm

[Go to Index](#)

BONE INSTRUMENTS

Elevators

OE 0121

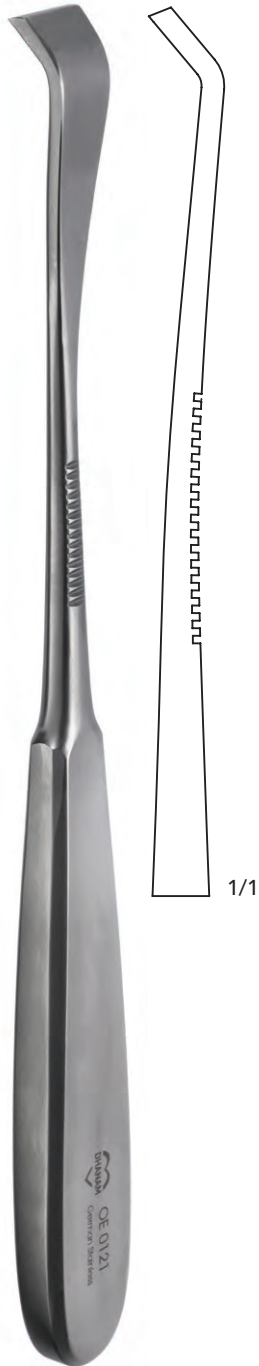

Forward

OE 0221



Reverse

OE 0321

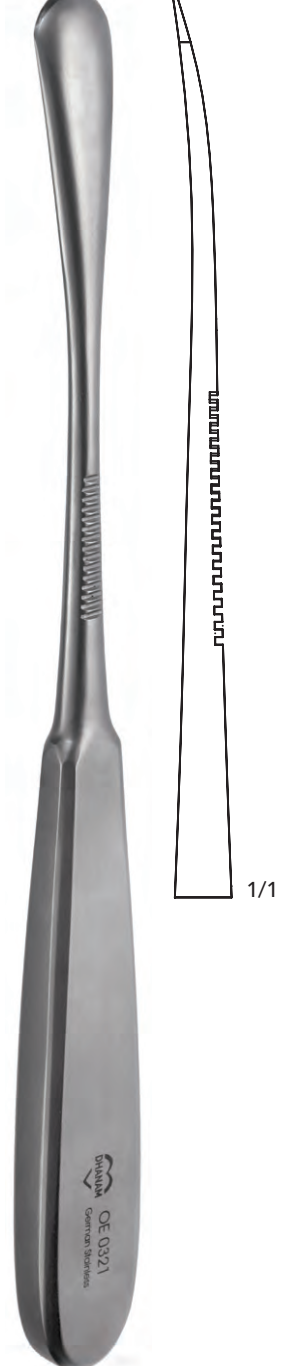

Curved

Semb Bone Raspatories 9", 230 mm (13mm Width)

[Go to Index](#)

BONE INSTRUMENTS

Rongeurs

OA 7118

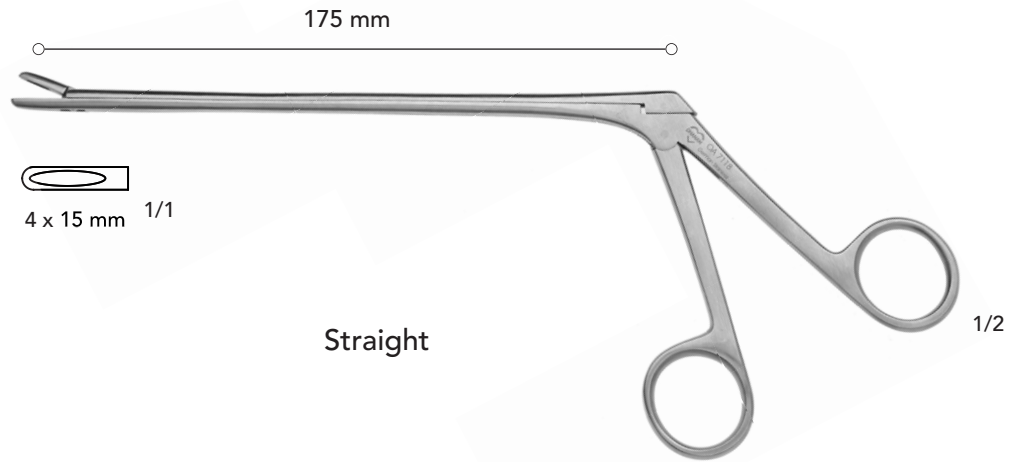

OA 7218

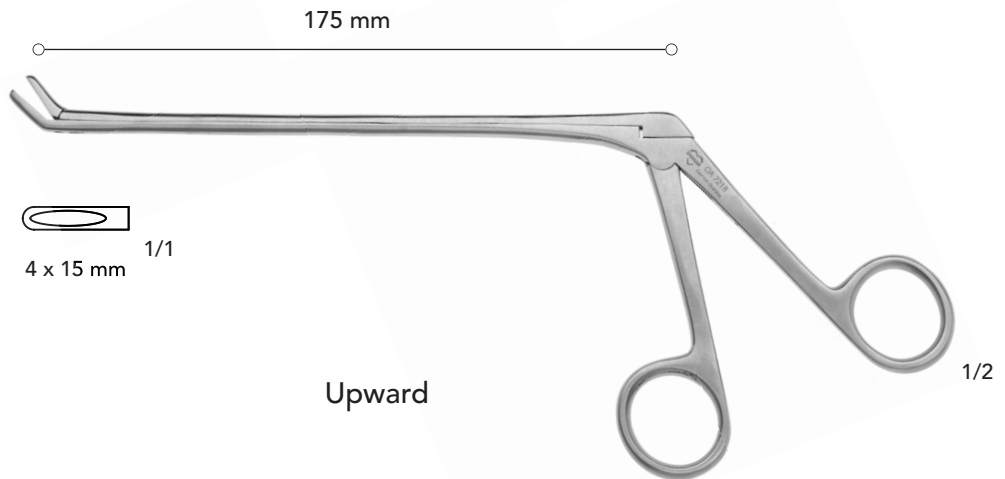

OA 7318

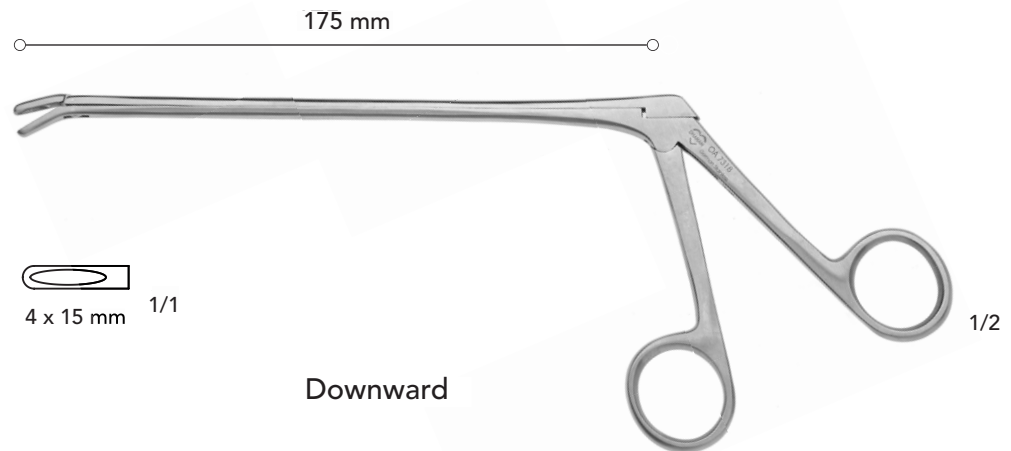

Aortic Valve Rongeurs 10", 250 mm

[Go to Index](#)

TRAYS AND CONTAINERS

CHAPTER - 09



TRAYS AND CONTAINERS

SS Trays with Lid

ST 1210



SS Tray with Lid 12" x 10"

ST 1512



SS Tray with Lid 15" x 12"

ST 1812



SS Tray with Lid 18" x 12"

[Go to Index](#)

MT 31194



Micro Instruments Tray with Silicon Mat
(310*190*40 mm)

A

Allison Lung Retractors	6.26
Angled Multi Purpose Clamps	2.6
Aortic Valve Retractors	6.17
Arota Aneurysm Clamps	2.18
Arota Clamps	2.16

B

Beck Clamps	2.11
Bone Cutters	8.1
Bone Instruments	8.0
BP Handles	5.1
Bulldog Clamps	1.28

C

Cardiotomy Suckers	3.12
Cardiotomy Suction Tubes	7.1
Chitwood Debakey Clamps	3.10
Clip Applicators	3.7
Cooly Mitral Valve Retractors	6.18
Coronary Probes	1.27
Cross Clamps	2.20

D

Davers Retractors	6.24
Davidson Retractors	6.25
Debakey Angled Clamps	2.29
Debakey Forceps	1.23
Debakey Side Biting Angled Clamps	2.28
Debakey Straight Clamp	2.27
Debakey Vascular Clamps	2.0
Deep Curved Multi Purpose Clamps	2.5
Delicate Forceps	1.22
Derra Cooley Clamps	2.7
Dessectors	1.30

Dilators	5.41
Dissecting Forceps	5.32

E

Elevators	8.3
Epicardial Fat Retractors	6.31

F

Forceps	5.3
---------	-----

G

General Instruments	5.0
---------------------	-----

H

Harrington Retractors	6.23
Herken Clamps	2.12
Hollow Wares	5.43
Hooks	6.33

I

IMA Retractor Arc + Coupler Set	3.2
Intercostal Retractor Set	3.1

K

Knot Pushers	3.8
--------------	-----

L

LA Attachment	3.3
Lambert-Key Clamps	2.15
Langenbeck Retractors	6.20
Ligature Clamps	2.10
Long Valve Forceps	3.5

ALPHABETICAL INDEX



M

Malliable Retractors	6.32
Micro Debakey Forceps	1.15
Micro Instruments	1
Micro Instruments Tray	9.2
MICS Instruments	3
Mini-sternotomy and Thorac. Retractor	3.4
Mories Retractors	6.27

N

Needle Holders (Debakey, Mayo and Ryder)	5.26
Needle Holders (Micro)	1.1
Neonatal Castaneda clamps	2.3
Nerve Hook	3.11

P

Platform Forceps	1.20
Price-Thomas Vascular Clamp	2.26
PTE (Madani) Debakey Forceps	4.1
PTE Instruments	4
Pulmonary Endarterectomy Dissector	4.2

R

Rack Retractors	6.28
Resano Forceps	1.26
Retractors	6
Rib / Sternal Spreaders	6.1
Ring Handle Bulldog Clamps	2.1
Ring Tip Forceps	1.12
Rongeurs	8.6
Rough Suction Tubes	7.2

S

Satinsky Clamps	2.14
Scissors (Potts and Supercut)	1.5
Scissors (Metzenbaum and Mayo)	5.20
Self Retaining Retractors	6.14
SEMB Arota Aneurysm Clamps	2.17
Side Biting Clamps	2.9
SS Trays with Lid	9.1
Sternal Needle / Wire Twister	5.30
Straight Clamps	2.19
Suction Instruments	7.0
Suction Tips	7.3
Suction Tips & Cannulas	7.4

T

Tangential Occlusion Clamps	2.13
Titanium Micro Clamps	2.27
Trays And Containers	9
Tube Holding Instruments	5.37

V

VSD Retractors	6.22
----------------	------

W

Wire Cutters	5.40
Wire Holder	5.31

Z

Zereny Retractor	6.30
------------------	------

[Go to Index](#)

*We appreciate your time spent with our catalog.
Looking forward to serving you.*



DHANAM INSTRUMENTS PRIVATE LIMITED

Plot No .17, Masilamani Street, Siva Vishnu Nagar, Kundrathur,
Chennai - 600069.

 info@dhanamsurgical.com  +91 99401 10238

 www.dhanamsurgical.com